



AC/DC

# ISOMETER® iso685(W)-D/-S

Insulation Monitoring Device

for IT AC systems with galvanically connected rectifiers and inverters and  
for IT DC systems

SW: D0438 V1.29 | D0437 V1.27





## Table of contents

<b>1</b>	<b>General information.....</b>	<b>6</b>
1.1	How to use the manual.....	6
1.2	Indication of important instructions and information.....	6
1.3	Signs and symbols.....	6
1.4	Service and Support.....	6
1.5	Training courses and seminars.....	7
1.6	Delivery conditions.....	7
1.7	Inspection, transport and storage.....	7
1.8	Warranty and liability.....	7
1.9	Disposal of Bender devices.....	8
1.10	Safety.....	8
<b>2</b>	<b>Function.....</b>	<b>9</b>
2.1	Intended use.....	9
2.2	Device features.....	10
2.3	Product description.....	10
2.4	Function description.....	11
2.5	Interfaces.....	11
2.6	Self test.....	12
<b>3</b>	<b>Device overview.....</b>	<b>13</b>
3.1	Dimensions.....	13
3.2	Variants.....	13
3.3	Connection.....	14
3.4	Display elements and device buttons.....	15
3.5	Operating and navigating.....	16
<b>4</b>	<b>Mounting.....</b>	<b>18</b>
4.1	General instructions.....	18
4.2	Mounting spaces.....	18
4.3	Screw mounting.....	19
4.4	DIN rail mounting.....	19
<b>5</b>	<b>Connection.....</b>	<b>20</b>
5.1	Connection requirements.....	20
5.2	Connection to a 3(N)AC system.....	21
5.3	Connection to an AC system.....	22
5.4	Connection to a DC system.....	22

5.5	Connection to a supply voltage.....	22
5.6	Connection to the X1 interface.....	24
5.7	Connection to the Ethernet interface ETH.....	24
5.8	Connection of the relay interfaces 1 and 2.....	25
5.9	Terminal covers.....	25
<b>6</b>	<b>Commissioning.....</b>	<b>26</b>
6.1	General commissioning process.....	26
6.2	Initial commissioning.....	26
6.3	Recommissioning.....	29
6.4	Configuring password protection.....	29
<b>7</b>	<b>Display.....</b>	<b>31</b>
7.1	Standard display.....	31
7.2	Fault display (active).....	31
7.3	Fault display (inactive).....	32
7.4	Acknowledging a fault message.....	33
7.5	History memory.....	33
7.6	Data - isoGraph.....	33
7.7	Initial measurement.....	34
7.8	Automatic test.....	34
<b>8</b>	<b>Settings in the device menu.....</b>	<b>35</b>
8.1	Menu structure.....	35
8.2	Settings.....	36
8.2.1	Alarm settings.....	36
8.2.2	Data meas. values.....	48
8.2.3	Control.....	48
8.2.4	History.....	48
8.2.5	Device settings.....	48
8.2.6	Info.....	52
<b>9</b>	<b>Device communication.....</b>	<b>53</b>
9.1	Ethernet interface.....	53
9.2	BCOM.....	53
9.3	Modbus TCP.....	53
9.4	Web server.....	53
9.4.1	Conventions.....	54
9.4.2	Functions.....	54
9.4.3	User interface.....	55

9.4.4	Menu structure.....	56
9.4.5	Parameter changes.....	56
9.4.6	Changing parameters in a web browser.....	58
9.4.7	Changing parameters in the device menu when the web browser is open.....	58
9.4.8	Write access for parameter changes.....	59
9.5	BS bus.....	59
9.5.1	Master-slave principle.....	59
9.5.2	Addresses and address ranges on the BS bus.....	59
9.5.3	RS-485 specifications and cables.....	60
9.5.4	Cable routing.....	60
9.6	Modbus RTU.....	60
9.7	isoData protocol.....	61
<b>10</b>	<b>Coupling devices.....</b>	<b>64</b>
10.1	Connection using the AGH150W-4 (Art. No.: B98018006).....	64
10.2	Connection using the AGH520S (Art. No.: B913033).....	65
10.3	Connection using the AGH204S-4 (Art. No.: B914013).....	66
10.4	Connection using the AGH676S -4 (Art. No.: B913055).....	67
<b>11</b>	<b>Alarm messages.....</b>	<b>68</b>
11.1	General alarms.....	68
11.2	Measured value alarms.....	69
<b>12</b>	<b>Technical data.....</b>	<b>70</b>
12.1	Device profiles.....	70
12.2	Operating uncertainty.....	76
12.3	Factory settings.....	77
12.4	Tabular data.....	78
12.5	Standards and certifications.....	85
12.6	Ordering details.....	85
12.7	Document revision history.....	86
<b>13</b>	<b>Glossary.....</b>	<b>88</b>

# 1 General information

## 1.1 How to use the manual



### ADVICE

This manual is intended for qualified personnel working in electrical engineering and electronics! Part of the device documentation in addition to this manual is the enclosed supplement "Safety instructions for Bender products".



### ADVICE

Read the operating manual before mounting, connecting and commissioning the device. Keep the manual within easy reach for future reference.

## 1.2 Indication of important instructions and information



### DANGER

Indicates a high risk of danger that will result in death or serious injury if not avoided.



### WARNING

Indicates a medium risk of danger that can lead to death or serious injury if not avoided.



### CAUTION

Indicates a low-level risk that can result in minor or moderate injury or damage to property if not avoided.



### ADVICE

Indicates important facts that do not result in immediate injuries. They can lead to malfunctions if the device is handled incorrectly.



*Information can help to optimise the use of the product.*

## 1.3 Signs and symbols



Disposal



Protect from moisture



Protect from dust



Temperature range



Recycling



RoHS directives

## 1.4 Service and Support

Information and contact details about customer service, repair service or field service for Bender devices are available on the following website: [Fast assistance | Bender GmbH & Co. KG.](#)

## 1.5 Training courses and seminars

Regular face-to-face or online seminars for customers and other interested parties:

[www.bender.de](http://www.bender.de) > know-how > seminars.

## 1.6 Delivery conditions

The conditions of sale and delivery set out by Bender GmbH & Co. KG apply. These can be obtained in printed or electronic format.

The following applies to software products:



"Software clause in respect of the licensing of standard software as part of deliveries, modifications and changes to general delivery conditions for products and services in the electrical industry"

## 1.7 Inspection, transport and storage

Check the shipping and device packaging for transport damage and scope of delivery. In the event of complaints, the company must be notified immediately, see "[www.bender.de](http://www.bender.de) > service & support."

The following must be observed when storing the devices:

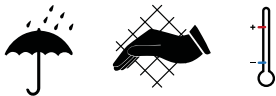

## 1.8 Warranty and liability

Warranty and liability claims for personal injury and property damage are excluded in the case of:

- Improper use of the device.
- Incorrect mounting, commissioning, operation and maintenance of the device.
- Failure to observe the instructions in this operating manual regarding transport, commissioning, operation and maintenance of the device.
- Unauthorised changes to the device made by parties other than the manufacturer.
- Non-observance of technical data.
- Repairs carried out incorrectly.
- The use of accessories or spare parts that are not provided, approved or recommended by the manufacturer.
- Catastrophes caused by external influences and force majeure.
- Mounting and installation with device combinations not approved or recommended by the manufacturer.

This operating manual and the enclosed safety instructions must be observed by all persons working with the device. Furthermore, the rules and regulations that apply for accident prevention at the place of use must be observed.

## 1.9 Disposal of Bender devices

Abide by the national regulations and laws governing the disposal of this device.



For more information on the disposal of Bender devices, refer to [www.bender.de](http://www.bender.de) > service & support.

## 1.10 Safety

If the device is used outside the Federal Republic of Germany, the applicable local standards and regulations must be complied with. In Europe, the European standard EN 50110 applies.



**DANGER** *Risk of fatal injury due to electric shock!*

*Touching live parts of the system carries the risk of:*

- Risk of electrocution due to electric shock
- Damage to the electrical installation
- Destruction of the device

Before installing the device and before working on its connections, make sure that the installation has been de-energised. The rules for working on electrical systems must be observed.



## 2 Function

### 2.1 Intended use

The ISOMETER® monitors the insulation resistance of unearthed AC/DC main circuits (IT systems). The application range of the different types is specified in the chapter "Technical data", page 70. For the iso685-x and iso685-x-B types, the operating range of the nominal voltage  $U_n$  can be extended via coupling devices.

DC components existing in AC/DC systems do not influence the operating characteristics. A separate supply voltage allows de-energised systems to be monitored too. The maximum permissible system leakage capacitance is provided in the technical data.

Intended use also includes

- the observation of all information in the operating manual and
- compliance with test intervals.

In order to meet the requirements of the applicable standards, customised parameter settings must be made on the equipment in order to adapt it to local equipment and operating conditions. Please heed the limits of the range of application indicated in the technical data.

Do not make any unauthorised changes to the device. Only use spare parts and optional accessories sold or recommended by the manufacturer.

Caution: This equipment is not intended for use in residential environments and may not provide adequate protection to radio reception in such environments.

Any other use than that described in this manual is regarded as improper.

#### Device-specific safety information



##### **Installation inside a control cabinet**

*If the ISOMETER® is installed inside a control cabinet, the insulation fault message must be audible and/or visible to attract attention.*

##### **IT systems with several ISOMETER®s**

*Only one ISOMETER® may be connected in a galvanically connected system. In IT systems that are interconnected via tie switches, ISOMETER®s that are not required must be disconnected from the IT system or switched to inactive.*

*If IT systems are coupled via capacitors or diodes, a central control of the various ISOMETER® must be used.*

##### **Prevent measurement errors!**

*In galvanically coupled DC circuits, an insulation fault can only be detected correctly if a minimum current of > 10 mA flows through the rectifiers.*

##### **Unspecified frequency range**

*Depending on the application and the selected measurement profile, continuous insulation monitoring is also possible in low frequency ranges. For IT systems with frequency components above the specified frequency range, there is no influence on the insulation monitoring.*

## 2.2 Device features

- ISOMETER® for IT AC systems with galvanically connected rectifiers or inverters and for IT DC systems (IT = unearthed systems)
- Automatic adaptation to the existing system leakage capacitance
- Combination of **AMPPLUS** and other profile-specific measurement methods
- Two separately adjustable response value ranges of 1 kΩ ... 10 MΩ
- Graphical LC display
- Connection monitoring (monitoring of the measuring lines)
- Automatic device self test
- Graphical representation of the insulation resistance over time (isoGraph)
- History memory with real-time clock (buffer for three days) for storing 1023 alarm messages with date and time
- Current or voltage output 0(4)...20 mA, 0...400 μA, 0...10 V, 2...10 V (galvanically separated), which is analogous to the measured insulation value of the system
- Freely programmable digital inputs and outputs
- Remote setting via the Internet or Intranet (web server/option: COMTRAXX® gateway)
- Remote diagnosis via the Internet (made available by Bender Service only)
- isoData: permanent uninterrupted data transmission
- RS-485/BS (Bender sensor bus) for data exchange with other Bender devices via Modbus RTU protocol
- BCOM, Modbus TCP and web server

## 2.3 Product description

### General product description

The ISOMETER® is an insulation monitoring device for IT systems in accordance with IEC 61557-8.

It is universally applicable in AC, 3(N)AC, AC/DC and DC systems. AC systems may include extensive DC-supplied loads (such as rectifiers, inverters, variable-speed drives).

### Special ISOMETER® characteristics

The ISOMETER® iso685-D... belongs to the iso685 device family and features an integrated display. This manual applies in full to this ISOMETER®.

The ISOMETER® iso685-S... is the sensor variant of the iso685 device family. The only difference between this variant and the ISOMETER® iso685-D... is that it does not have a display. The ISOMETER® iso685-S... must be used in combination with a front panel through which it is operated. The operation of the front panel is equal to the operation of the ISOMETER® with an integrated display.

**i** *Only the sensor variant (i.e. ISOMETER® iso685-S...) can be connected to the front panel. Connection to the display variant (i.e. ISOMETER® iso685-D...) is not possible.*

Hereafter, the ISOMETER®s with integrated display are described. This description is similar to the combination of ISOMETER® sensor variants and the front panel FP200. The devices to which this manual applies will be referred to as ISOMETER®s hereafter.

## 2.4 Function description

The insulation monitoring device continuously monitors the entire insulation resistance of an IT system during operation and triggers an alarm when the value falls below a preset response value.

For measurement, the device has to be connected between the IT system and the protective earth conductor (PE). A measuring current in the  $\mu\text{A}$  range is superimposed onto the system which is recorded and evaluated by a microprocessor-controlled measuring circuit. The measuring time is dependent on the selected measurement profiles, the system leakage capacitance, the insulation resistance and possible system-related disturbances.

The response values and other parameters are set using a commissioning wizard as well as via different setup menus using the device buttons and a graphical LC display. The selected settings are stored in a permanent fail-safe memory. Different languages can be selected for the setup menus as well as the messages indicated on the display. The device utilises a clock for storing fault messages and events in a history memory with time and date stamp. The settings can be password protected to prevent unauthorised changes.

To ensure proper functioning of connection monitoring, the device requires the setting of the system type 3AC, AC or DC and the required use of the appropriate terminals L1/+, L2, L3/-.

To extend the operating range of the nominal voltage, various coupling devices are available as accessories, which can be selected and adjusted via a menu.

The insulation monitoring device iso685... is able to measure the insulation resistance reliably and precisely in all common IT systems. Due to various applications, system types, operating conditions, application of variable-speed drives, high system leakage capacitances etc., the measuring instruments must be able to meet varying requirements in order to ensure an optimised response time and relative uncertainty. Therefore different measuring profiles can be selected with which the device can be optimally adjusted.

If the preset response value falls below the value of Alarm 1 and/or Alarm 2, the associated alarm relays switch, the **ALARM 1** or **ALARM 2** LEDs light, and the measured value is shown on the LC display (in case of insulation faults in DC systems, a trend graph for the faulty conductor L+/L- is displayed). If the fault memory is activated, the fault message will be stored.

Pressing the **RESET** button resets the insulation fault message, provided that the insulation resistance displayed at the time of the resetting is at least 25 % above the actual response value.

As additional information, the quality of the measuring signal and the time required to update the measured value are shown on the display. A poor signal quality (1-2 bars) may be an indication that the wrong measurement profile is selected.

## 2.5 Interfaces

- Communication protocol Modbus TCP
- Communication protocol Modbus RTU
- BCOM for communication of Bender devices via Ethernet
- BS bus for communication of Bender devices (RS-485)
- isoData for recording and managing measured values
- Integrated web server for reading out measured values and setting parameters

## 2.6 Self test

After the voltage supply has been switched on, the ISOMETER® conducts a self-test during which it automatically and continuously checks all internal measuring functions, the components of the process control such as the data and parameter memory, as well as the connections to the IT system and earth.

The self test can also be activated manually by means of the test button to check the functions of the relays (depending on the configuration) or it can be selected via the **Control** menu (refer to “Control”, page 48).

If the relays are checked during the self-test, they switch for 2 seconds.

The progress of the manual self test is shown on the LC display by a bar graph. Depending on the conditions in the IT system being monitored, the self test is completed after 15...20 seconds. The device then returns to the standard mode (measurement mode), and the currently measured value will be displayed after the measuring time has expired. The display shows the message **Initial measurement** until the first valid value is measured (refer to “Initial measurement”, page 34).

If a fault is detected during the self test, the respective LEDs of the device light (refer to “Alarm messages”, page 68). In addition, the respective message will be indicated on the display and a previously programmed output will provide the respective signal.

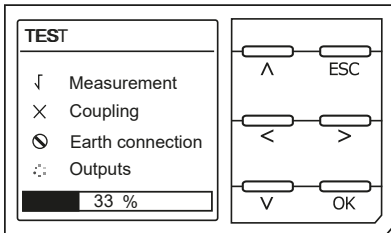

Test successful

Test unsuccessful

Test not available  
(e.g. incorrect device settings)

Testing...

### 3 Device overview

#### 3.1 Dimensions

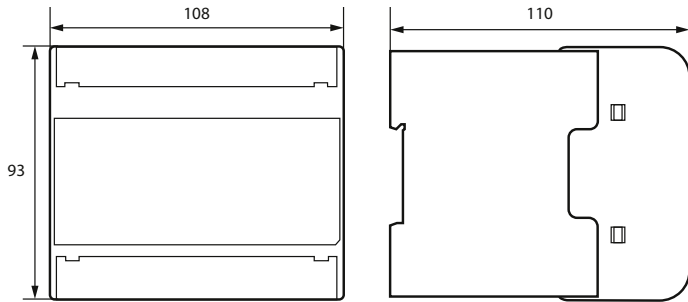
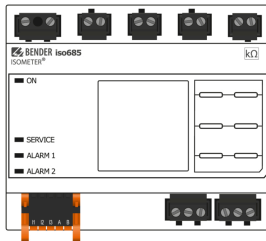

Figure: Enclosure iso685...-device family – dimensions in mm

#### 3.2 Variants

- iso685(W)-D...**, **isoxx685(W)-D...**      Graphic LC display and operating controls.  
Cannot be combined with the FP200(W).



- iso685(W)-S...**, **isoxx685(W)-S...**      No display and no operating controls.  
Can only be operated in combination with the FP200(W).

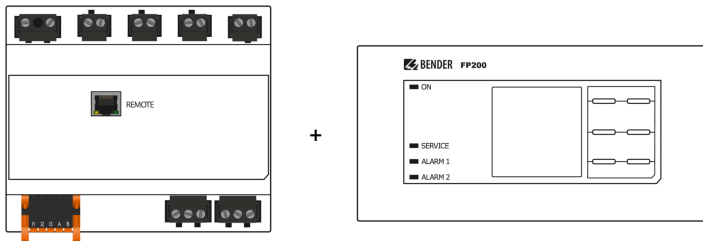

### 3.3 Connection

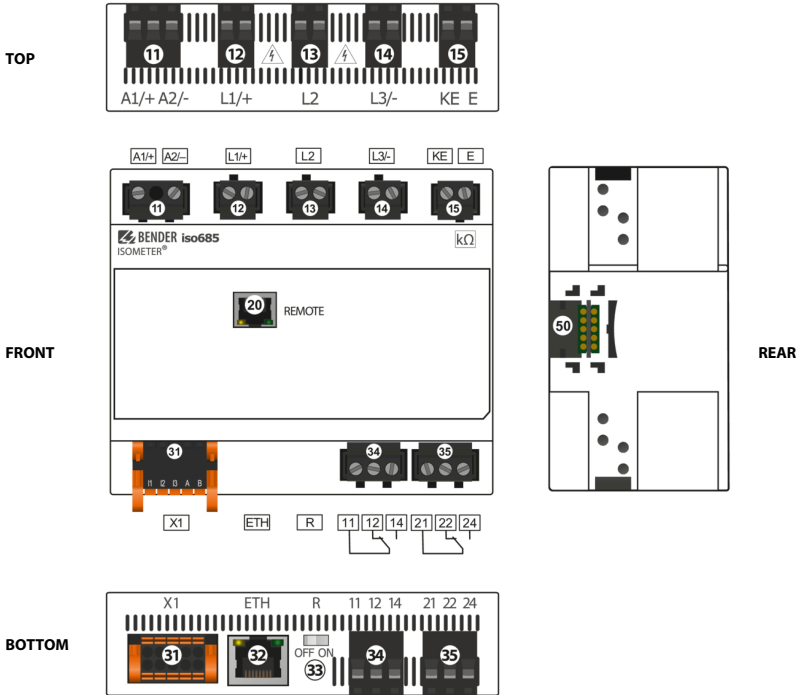

11	A1/+, A2/-	Connection to the power supply voltage $U_i$
12	L1/+	Connector for the IT system to be monitored
13	L2	Connector for the IT system to be monitored
14	L3/-	Connector for the IT system to be monitored
15	KE, E	Connection to PE
20	X4	isoxx685(W)-S... only: connector for the FP200(W)
31	X1	Multifunctional I/O interface
32	ETH (X2)	Ethernet interface
33	R	Switchable terminating resistor for termination of the RS-485 interface
34	11 12 14	Connector for alarm relay 1
35	21 22 24	Connector for alarm relay 2
50	BB-Bus	isoxx685(W)-x-P... only: optional expansion interface for Bender products

**i** *The connection between the iso685 device and an FP200(W) can be interrupted and restored at any time (Plug&Play), but is only recommended in a de-energised state.*

### 3.4 Display elements and device buttons

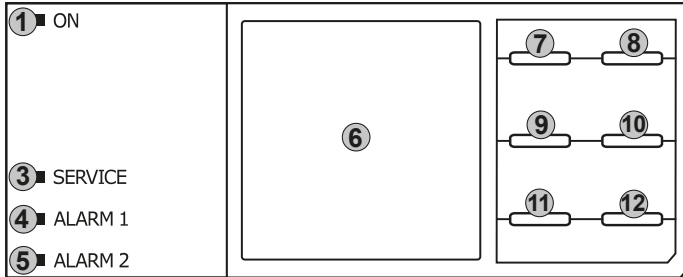

#### Display elements

1	<b>ON</b>	The <b>ON</b> LED lights when the device is turned on.
3	<b>SERVICE</b>	The <b>SERVICE</b> LED lights when there is either a device error or a connection fault, or when the device is in maintenance mode.
4	<b>ALARM 1</b>	The <b>ALARM 1</b> LED lights when the insulation resistance of the IT system falls below the set response value $R_{an1}$ .
5	<b>ALARM 2</b>	The <b>ALARM 2</b> LED lights when the insulation resistance of the IT system falls below the set response value $R_{an2}$ .
6	<b>Display</b>	The device display shows information regarding the device and the measurements. Further information is available in "Display", page 31.

#### Device buttons

You can adjust the device settings in the respective menu using the device buttons. Depending on the menu entry, one of the options displayed below is assigned to the buttons.

7	<b>^</b>	Navigates up in a list or increases a value.
8	<b>MENU</b> <b>ESC</b>	Opens the device menu. Cancels the current process or navigates one step back in the device menu.
9	<b>RESET</b> <b>&lt;</b>	Resets alarms. Navigates backwards (e.g. to the previous setting step) or selects parameter.
10	<b>TEST</b> <b>&gt;</b>	Starts the device self test. Navigates forwards (e.g. to the next setting step) or selects parameter.
11	<b>DATA</b> <b>v</b>	Indicates data and values. Navigates down in a list or reduces a value.
12	<b>INFO</b> <b>OK</b>	Shows information. Confirms an action or a selection.

### 3.5 Operating and navigating

#### Menu selection

Activate the menu by pressing the **MENU** button.

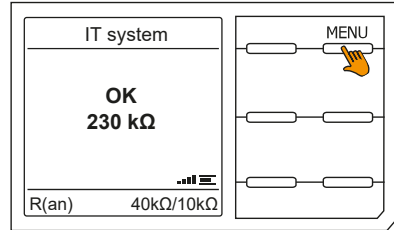

#### Selection of submenus

Use the and buttons  $\wedge$  and  $\vee$  to select the options. Press the button  $>$  or **OK** to jump to the next submenu for the selected options. Exit the menu by pressing the button  $<$  or **ESC**. To return to the start page, press the ESC button for 2 seconds.

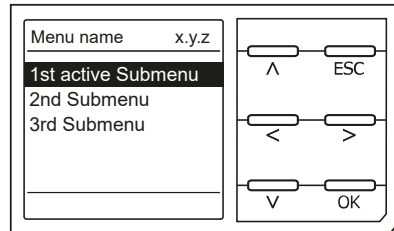

#### List selection

Use the buttons  $\vee$  and  $\wedge$  to select values from a predefined list (menu). The present value is indicated by a black menu item. Confirm the value with the **OK** button. Exit the list selection by pressing **ESC**.

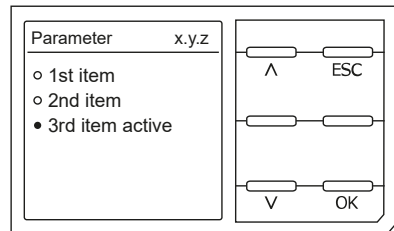

#### Parameter selection and value adjustment

Use the buttons  $<$  and  $>$  to select a parameter. The present parameter is highlighted. Values can be changed using the buttons  $\vee$  and  $\wedge$ . Confirm the value with the **OK** button. Exit the list selection by pressing **ESC**.

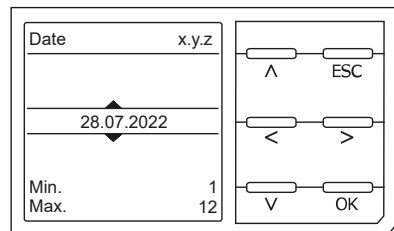



### Character input

Use the buttons < and > to select a character position on the display. Change a character with the buttons ^ and v.

To delete a character, use the < and > buttons to select the position and then select **del** using the v and ^ buttons.

Confirm the entered text with **OK**. Exit the character input by pressing **ESC**.

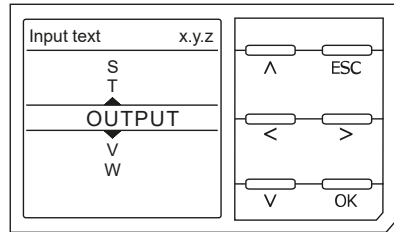

### Multiple selection in the device menu

Use the buttons ^ and v to select options (**Select all**, **No selection**, **Invert selection**) and the channels. Confirm the entered text with **OK**.

For the selected channels, press the > button to activate or to jump to the next submenu.

Exit the menu by pressing **ESC**.

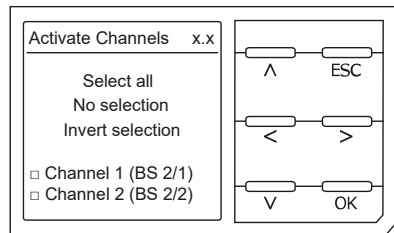

## 4 Mounting

### 4.1 General instructions



Only skilled persons are permitted to carry out the work necessary to install, put into service and run a device or system.



#### ADVICE

Read the operating manual before mounting, connecting and commissioning the device. Keep the manual within easy reach for future reference.



#### DANGER Risk of fatal injury due to electric shock!

Touching live parts of the system carries the risk of:

- Risk of electrocution due to electric shock
- Damage to the electrical installation
- Destruction of the device

Before installing the device and before working on its connections, make sure that the installation has been de-energised. The rules for working on electrical systems must be observed.

### 4.2 Mounting spaces

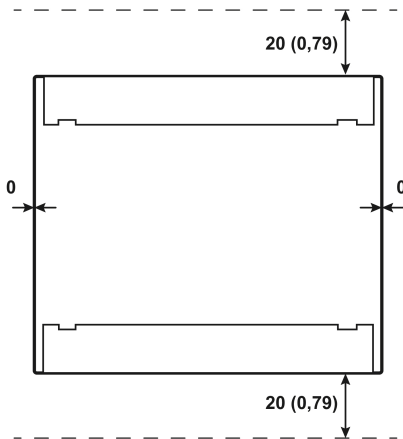
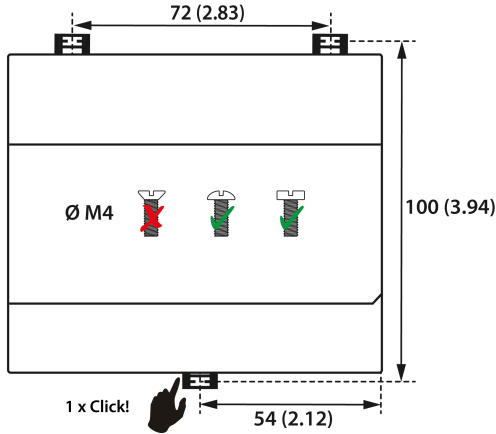

Figure 4-1: Mounting spaces; Dimensions in mm (in)

### 4.3 Screw mounting



1. Fix the three mounting clips as illustrated.
2. Drill the mounting holes for the M4 thread according to the drilling template.
3. Fix the device with three M4 or #10 screws.

Figure 4-2: Screw mounting; dimensions in mm (in)

### 4.4 DIN rail mounting

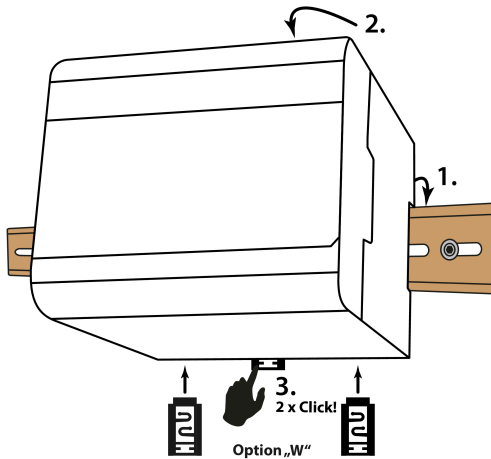

1. Snap the device on the DIN rail.
2. Press the device lightly onto the DIN rail.
3. To fix the device, push the mounting clip into the centre position until it clicks into place. For devices with option **W**, also attach the two separately packed mounting clips.

Figure 4-3: DIN rail mounting

## 5 Connection

### 5.1 Connection requirements



Only skilled persons are permitted to carry out the work necessary to install, put into service and run a device or system.



**DANGER Risk of fatal injury due to electric shock!**

Touching live parts of the system carries the risk of:

- Risk of electrocution due to electric shock
- Damage to the electrical installation
- Destruction of the device

Before installing the device and before working on its connections, make sure that the installation has been de-energised. The rules for working on electrical systems must be observed.



**DANGER Electric shock!**

High voltages may be present at the terminals **L1/+** to **L3/-**. Direct contact with these will likely result in electrocution.

- Only operate the device with mounted and locked terminal covers.
- If the terminals **L1/+**, **L2**, **L3/-** of the device are connected to a live IT system, do not disconnect terminals **KE** and **E** from the protective conductor **PE**.
- Connect terminals **KE** and **E** individually to the protective earth conductor **PE**.



**WARNING Injury, fire and damage to property due to a short circuit!**

According to DIN VDE 0100-430, devices used to protect against a short circuit when terminals **L1/+**, **L2** and **L3/-** are coupled to the IT system to be monitored can be omitted if the wiring is designed in such a manner that the risk of a short circuit is reduced to a minimum.

Ensure short-circuit-proof and earth-fault-proof wiring.



**CAUTION**

**Provide line protection!**

According to IEC 60364-4-43, a line protection shall be provided for the supply voltage.

**Risk of injury from sharp-edged terminals!**

Risk of lacerations. Handle enclosure and terminals with care.

**Ensure disconnection from the IT system!**

When insulation or voltage tests are to be carried out, the device must be isolated from the system for the test period. Otherwise the device may be damaged.

**Property damage due to improper installation!**

Make sure that only one insulation monitoring device is connected in each conductively connected system. If several devices are connected, the device does not work and does not signal insulation faults. This can damage the installation.

High load currents can result in damage to property and personal injury. Therefore, do not apply any load current to the terminals. The connecting lines **L1/+**, **L2**, **L3/-** to the system to be monitored must be designed as spur lines.

Failure to connect the device as illustrated in the manual leads to deviating technical data and function restrictions.



**Check proper connection!**

*Prior to commissioning the installation, check that the device has been properly connected and check the device functions. Perform a functional test using an earth fault via a suitable resistance.*

**Prevent measurement errors!**

*If a monitored AC system contains galvanically coupled DC circuits, the following applies: An insulation fault can only be detected with its correct value when the rectifier valves carry a minimum current of > 10 mA.*

**For UL applications**

*Use 60/75 °C copper lines only! For UL and CSA applications, the supply voltage must be protected via 5 A fuses.*

**5.2 Connection to a 3(N)AC system**

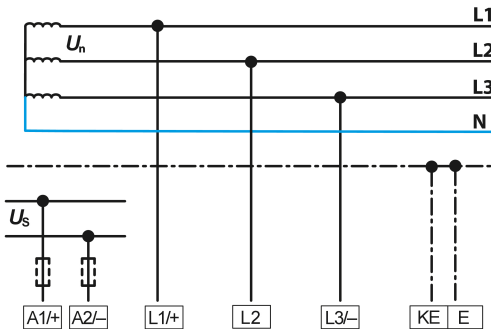

### 5.3 Connection to an AC system

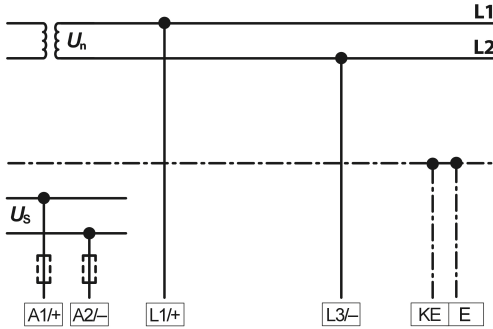

### 5.4 Connection to a DC system

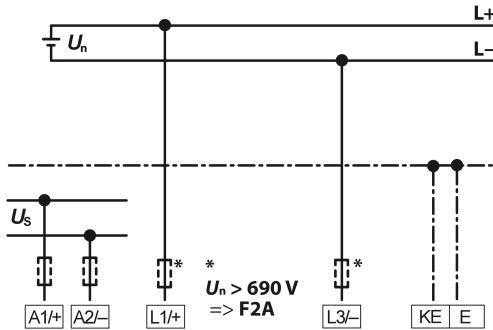

**i** In systems with a nominal system voltage of more than 690 V and with overvoltage category III, a fuse for the connection to the system to be monitored must be provided. \* 2 A fuses recommended.

### 5.5 Connection to a supply voltage



**CAUTION** **Damage to property due to faulty connection!**

The device may be damaged if it is simultaneously connected to the supply voltage via the **X1** interface and via **A1+/** and **A2/-**.

Do not connect the device simultaneously via **A1+/**, **A2/-** and **X1** to different supply voltage sources.

**i** **Voltage supply via external power supply units**  
 In case of external supply (24 V) the device can be supplied EITHER via **A1/+** and **A2/-** OR via **X1**. In case of supply via **A1/+** and **A2/-**, make sure that +24 V are applied to **A1/+** and that **A2/-** is connected to **GND** (ground).

**Back-up fuse for voltage supply**

If the device is supplied via an external power supply unit, the back-up fuse  $F_{back-up}$  at connection **A1/+**, **A2/-** must be selected so that the feeding power supply unit is able to trip the DC-compatible back-up fuse. Example: A back-up fuse of 650 mA/T is recommended when using a 24 V power supply unit (min. 1 A).

**Emission requirements for external voltage supply**

External power supply units that supply the ISOMETER® via **X1** must meet the immunity and emission requirements of the relevant application standard. For connecting cables longer than 1 m, shielded cables must be used.

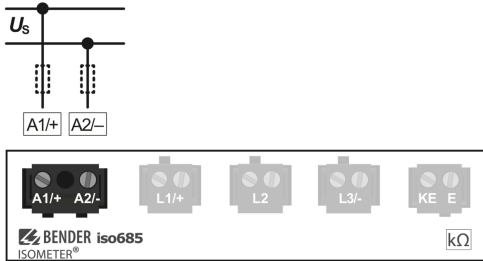

## 5.6 Connection to the X1 interface

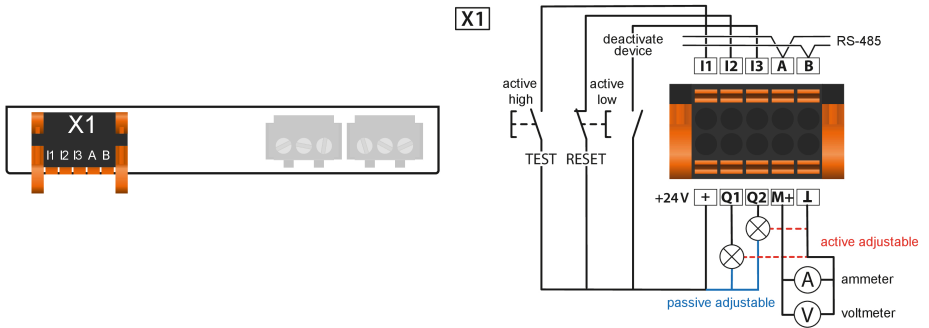

<b>I1 ... I3</b>	Configurable digital inputs (e.g. test, reset, ...)
<b>A, B</b>	Serial interface RS-485, termination by means of a DIP switch <b>R</b> .
<b>+</b>	Supply voltage of the inputs and outputs I, Q and M. Electrical overload protection. Automatic shutdown in the event of short circuits and transients (resettable). When supplied via an external 24 V source, A1/+, A2/- must not be connected.
<b>Q1, Q2</b>	Configurable digital output
<b>M+</b>	Configurable analogue output (e.g. measuring instrument)
<b>⊥</b>	Reference potential ground

## 5.7 Connection to the Ethernet interface ETH

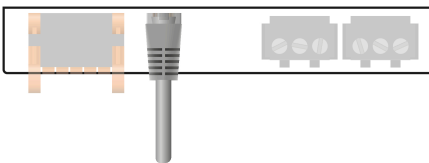

Connection with standard patch cable (RJ45/no crossover cable) to other ISOMETER®s or interconnection of several ISOMETER®s in star topology via a switch.



### 5.8 Connection of the relay interfaces 1 and 2

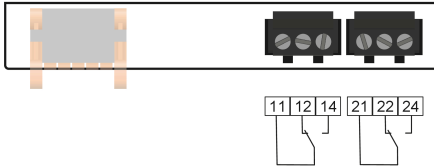

<b>Relay 1</b>	11 common contact	12 N/C contacts	14 N/O contacts
<b>Relay 2</b>	21 common contact	22 N/C contacts	24 N/O contacts

### 5.9 Terminal covers

Insert the terminal covers into the recesses provided in the enclosure until they click into place.

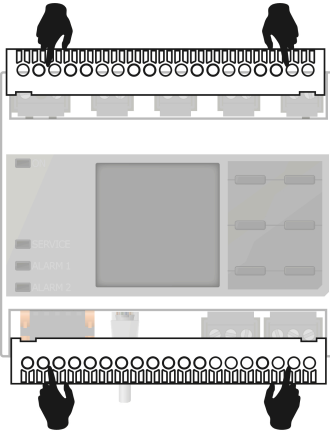

## 6 Commissioning

### 6.1 General commissioning process

1. Check that the ISOMETER® is properly connected to the system to be monitored.
  2. Connect the supply voltage to the ISOMETER®.
  3. Set the device via the commissioning wizard.
- ✓ The ISOMETER® performs a self test in four steps. The alarm relays are not checked during this test. The measured insulation resistance is shown on the display. If the value exceeds the response values indicated in the lowest line of the display, the message **OK** will additionally be displayed.



*For customer-specific configured devices, the commissioning wizard might be deactivated and cannot be run. In this case, the device is preset. However, the commissioning wizard can be started as described at "Recommissioning", page 29 below.*

4. Check the ISOMETER® in the system being monitored, e.g. using a suitable resistor to earth.



**Observe the device status!** *The device is in an alarm state until initial commissioning has been completed.*

#### Commissioning procedure

Step	ISOMETER® commissioning
1.	Connect the device according to the wiring diagram and device documentation.
2.	Switch on supply voltage.
3.	Switch on mains voltage.
4.	Run the commissioning wizard.
5.	The ISOMETER® performs a self test.
6.	Run a function test with a suitable resistor between the system and earth.
7.	Remove resistance.
8.	Adjust the default settings, where applicable.
9.	The ISOMETER® is fully functional and correctly connected.

### 6.2 Initial commissioning



#### **Check network function!**

*When the device has been integrated into a network, the influence on the network has to be checked with the device switched on and off.*

Follow the instructions of the commissioning wizard on the display.

## Setting the language

The language selected here will be used in the menu and for device messages.

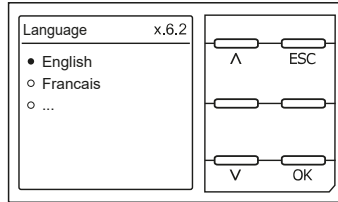

## Setting date and time

Alarm messages in the history memory and the insulation resistance value over time can only be assigned correctly to the isoGraph when date and time are set correctly.

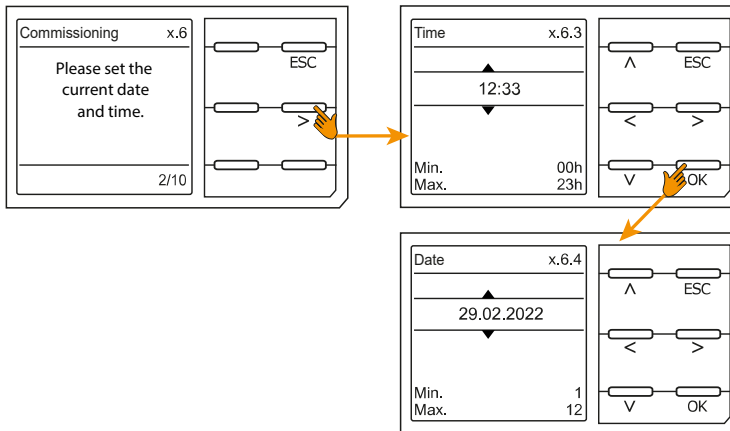

## Setting system type

When the system type is set, the insulation monitoring device is optimally adapted to the system to be monitored. The system type is essential information for the insulation monitoring device in order to determine the insulation resistance correctly.

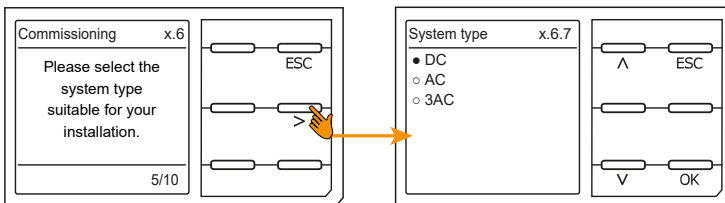

### Coupling

A coupling device connected to the insulation monitoring device (to increase the nominal system voltage) must be programmed here. The measurement of the insulation resistance takes into account the parameters of the connected coupling device. If no coupling device is available, press **OK**.

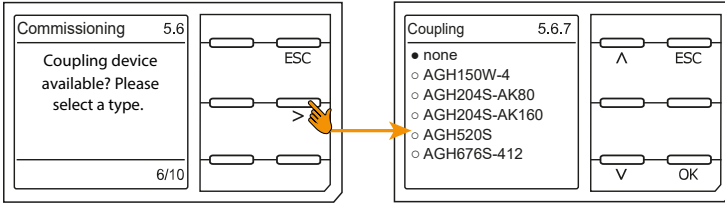

### Setting the profile

In order to optimally adapt the insulation monitoring device to the system to be monitored, you can select a profile here that is suitable for your installation. For an overview of the available profiles refer to "Technical data", page 70. The **Power circuits** profile is suitable for most of the IT systems.

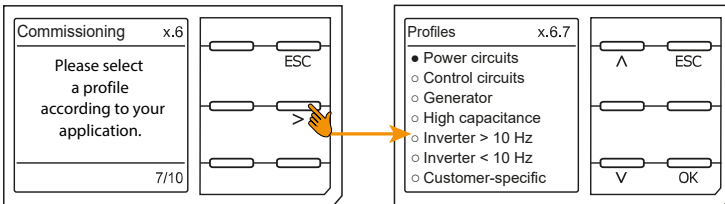

### Setting response value $R_{an1}$ for Alarm 1

You can set the prewarning response value here.

Recommendation: 100  $\Omega/V$

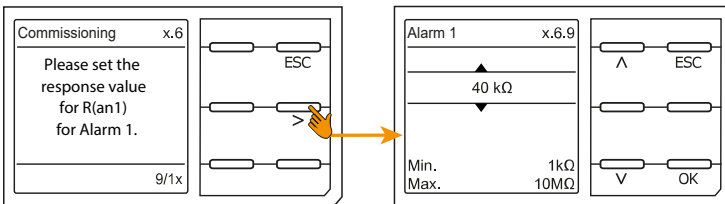

### Setting response value $R_{an2}$ for Alarm 2

You can set the response value for the main alarm here.

Recommendation: 50  $\Omega/V$

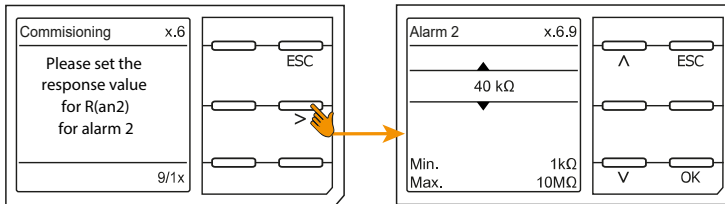

After setting the response value  $R_{an2}$  for alarm 2, the device starts a self test, makes the initial measurement and outputs the measured insulation resistance values of the IT system being monitored, then commissioning is completed.

### 6.3 Recommissioning

If the device has already been put into operation once, the self test will be carried out shortly after the supply voltage has been connected. If you want to modify settings, start the commissioning wizard:

**MENU: Device settings > Commissioning**

**i** **Observe device status!**  
 Once initial commissioning has been completed and the initial measurement taken, the device changes from the alarm state to normal state by adhering to the set response values.

### 6.4 Configuring password protection

You can assign a password in the device menu.

- Select device menu:  
**MENU: Device settings > Password**
- Activate the password in submenu **Status** by selecting the setting **on**.
- Set a four-digit password in submenu **Password**. You can use the digits 0 to 9.

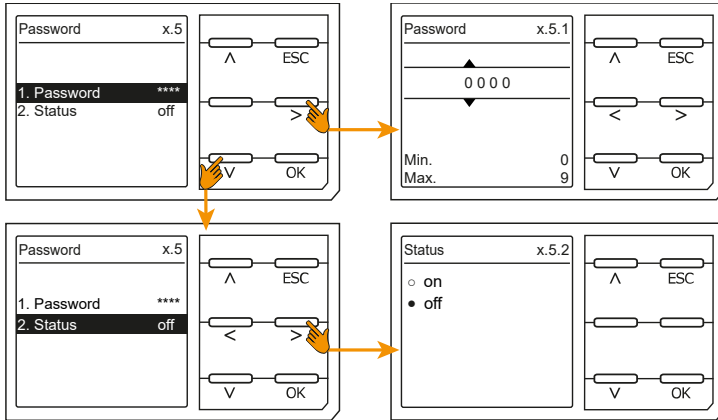

## 7 Display

### 7.1 Standard display

During normal operation, the ISOMETER® displays the message **OK** and below, the currently measured insulation resistance.

	<b>The signal quality of the measurement is suitable for the selected profile</b> The better the signal quality, the faster and more exact the device can measure.
	<b>The signal quality of the measurement is not suitable for the selected profile</b> Select a different measurement profile. (See "Device profiles", page 70.)
	Progress bar between two measuring pulses

The set response values for  $R_{an1}$  and  $R_{an2}$  are shown in the bottom row of the display.

In the example below,  $R_{an1} = 40 \text{ k}\Omega$  and  $R_{an2} = 10 \text{ k}\Omega$ .

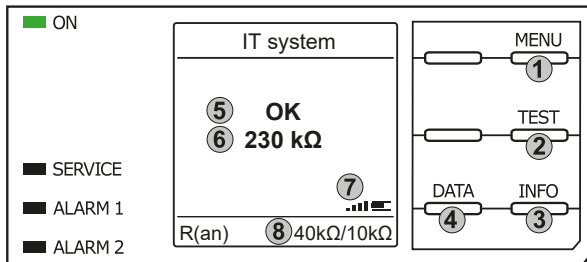

Keypad

1. Menu selection
2. Start Test
3. Device information
4. Measuring data displayed as graph

Display

5. System state
6. Currently measured value
7. Signal quality and progress bar
8. Currently set values for prewarning and main alarm

### 7.2 Fault display (active)



An active fault is displayed by the general warning sign. The upper part of the display turns orange and displays the fault message.

Depending on the type of fault, the LEDs **ALARM 1**, **ALARM 2** or **SERVICE** are activated.

In the following example, a resistance has been detected. Since the values  $R_{an1}$  and  $R_{an2}$  are both below the set response value, **ALARM 1** and **ALARM 2** have been triggered.

If several fault messages have appeared, you can navigate through the faults using the  $\nabla$  and  $\wedge$  buttons.

If the value falls below  $R_{an1}$  in a DC system or a DC offset is detected in an AC system, additional detailed information regarding the DC offset will be displayed.

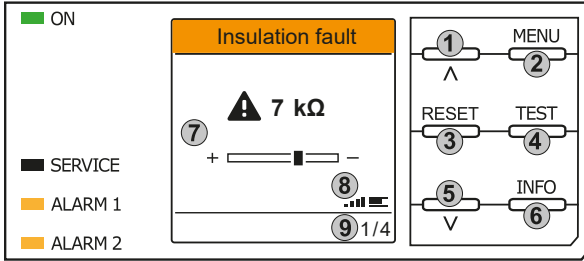

Keypad

1. Previous fault
2. Menu selection
3. Acknowledge fault
4. Start test
5. Next fault
6. Device information

Display

7. Display of fault value and DC shift
8. Signal quality and progress bar
9. xth fault of

### 7.3 Fault display (inactive)

An inactive fault is displayed by an encircled **i**. If several faults have occurred, the number of faults will also be indicated.

The message shown on the display means that there has been a fault in the past but the device is no longer in active fault condition.

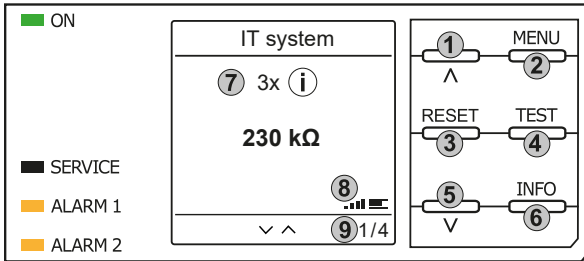

Keypad

1. Previous fault message
2. Menu selection
3. Acknowledge fault
4. Perform manual device test
5. Next fault message
6. Device information

Display

7. Fault number /fault message count
8. Signal quality & measuring pulses
9. Number of the selected fault/Fault message count

If several fault messages have occurred, navigate through the faults using the **V** and **^** buttons. In addition to the type of fault and the associated alarm value, you can see when the fault has occurred and how long it has been active.

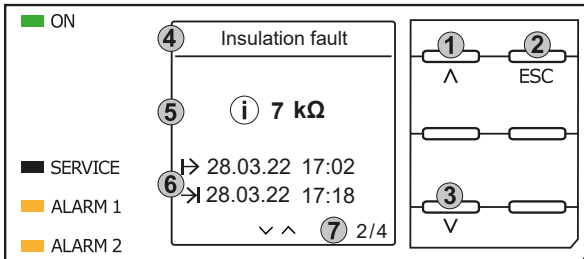

Keypad

1. Previous fault message
2. Exit view
3. Next fault message

Display

4. Fault description
5. Alarm value
6. Fault appeared / fault disappeared
7. Number of the selected fault/Fault message count



## 7.4 Acknowledging a fault message

In order to acknowledge the fault message and return to the ISOMETER®'s standard display, all faults must be acknowledged by means of the **RESET** button.

This means that fault messages can only be reset when the cause of fault has been eliminated.

Press the **RESET** button, then **>** and **OK** to clear the fault memory. The ISOMETER® then returns to the standard display.

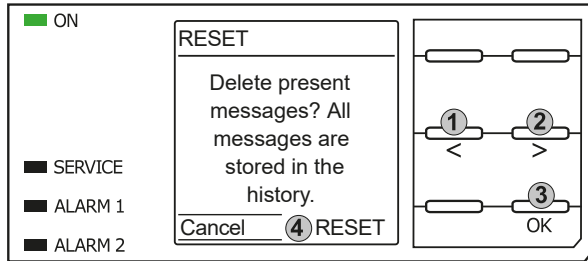

Keypad

1. Select Cancel.
2. Select RESET.
3. Confirm function.

Display

4. Functions Cancel / Reset

## 7.5 History memory

Up to 1023 alarm messages and device errors are stored in the history memory with date and time stamp. If the history memory is deleted, the minimum insulation resistance  $R_{\min}$  will also be reset at:

**MENU: Data meas. values > Data - isoGraph**

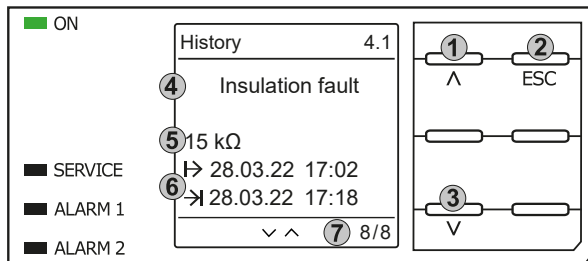

Keypad

1. Next message
2. Exit view
3. Previous message

Display

4. Fault description
5. Alarm value
6. Fault appeared / fault disappeared
7. Number of the selected fault/Fault message count

## 7.6 Data - isoGraph

The isoGraph represents the chronological sequence of the insulation resistance over time. This graphical representation can be displayed over the following time periods: hour, day, week, month and year. The measured values for individual representations are stored in a separate memory. Up to 100 measured values are available to show each graph on the display, and the resolution of each graph is determined by these values.

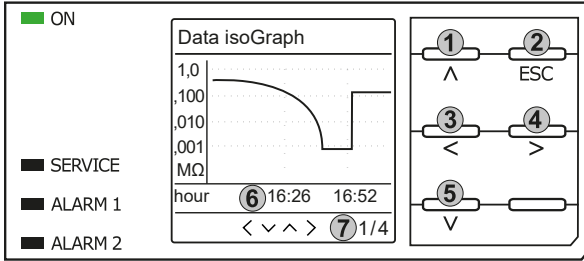

Keypad

1. Switch to previous measured value overview
2. Exit view
3. Change scaling (zoom in)
4. Change scaling (zoom out)
5. Switch to next measured value overview

Display

6. Present time scaling
7. xth view of ...

### 7.7 Initial measurement

During the initial measurement, the device records all measured values.

All measured values that may have been recorded before will be discarded if a new initial measurement is started.

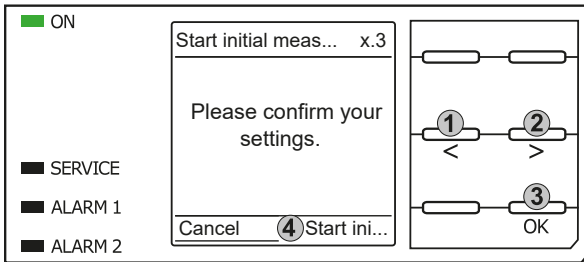

Keypad

1. Select cancel
2. Select function
3. Confirm

Display

4. Cancel | Start initial measurement

### 7.8 Automatic test

First, the ISOMETER® performs an automatic test. During the test, the connections to the IT system and to earth are tested. Afterwards, the ISOMETER® performs an initial measurement and records all measured values in the device (see also "Initial measurement", page 34).

The ISOMETER® then measures during one measuring cycle before passing on the authorisation for insulation measurement to the ISOMETER® with the next higher address.

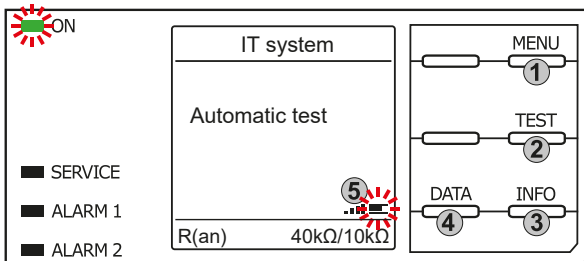

Keypad

1. Menu selection
2. Start Test
3. Device information
4. Display of the insulation level as a graph

Display

5. Signal quality and progress bar

## 8 Settings in the device menu

### 8.1 Menu structure

1. Alarm settings	<ol style="list-style-type: none"> <li>1. Insulation alarm                             <ol style="list-style-type: none"> <li>1. Alarm 1</li> <li>2. Alarm 2</li> <li>3. Fault memory</li> </ol> </li> <li>2. DC alarm                             <ol style="list-style-type: none"> <li>1. Alarm</li> <li>2. U(DC-E)</li> </ol> </li> <li>3. Profile</li> <li>4. System type</li> <li>5. t(start)</li> <li>6. Coupling monitoring</li> <li>7. Behaviour when inactive                             <ol style="list-style-type: none"> <li>1. Initial value</li> <li>2. Keep state</li> </ol> </li> </ol>
2. Data meas. values	
3. Control	<ol style="list-style-type: none"> <li>1. Digital 1</li> <li>2. Digital 2</li> <li>3. Digital 3</li> </ol>
4. History (only Delete protected)	
5. Device settings	<ol style="list-style-type: none"> <li>1. Relay 1</li> <li>2. Relay 2</li> <li>3. Digital 1</li> <li>4. Digital 2</li> <li>5. Buzzer</li> <li>6. Analogue</li> </ol>
6. Info	<ol style="list-style-type: none"> <li>1. TEST</li> <li>2. Reset</li> <li>3. Start initial measurement</li> <li>4. Device</li> </ol>
	<ol style="list-style-type: none"> <li>1. Language</li> <li>2. Clock (&amp; Date)</li> <li>3. Interface</li> <li>4. Display</li> <li>5. Password</li> <li>6. Commissioning</li> <li>7. Backup</li> <li>8. Approve</li> <li>9. Factory settings</li> <li>10. Software</li> <li>11. Service</li> </ol>

## 8.2 Settings

### 8.2.1 Alarm settings

The limit values for the insulation resistances of Alarm 1 and Alarm 2 can be specified in the **Alarm settings** menu and can be adapted to the user profile of the ISOMETER®. A device password is required for entering the settings.

#### 8.2.1.1 Insulation alarm

In the **Insulation alarm** menu, the ISOMETER® limit values for **Alarm 1** and **Alarm 2** can be set.

Activation and deactivation of the two alarm levels  $R_{an1}$  for **Alarm 1** and  $R_{an2}$  for **Alarm 2** are illustrated in the following graphic.

An alarm will become inactive as soon as the hysteresis of the set operating value is exceeded.

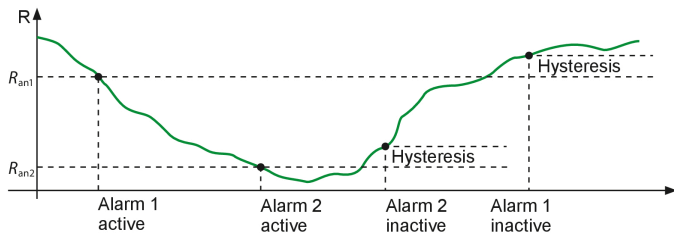

#### Menu item: Alarm 1

For **Alarm 1** an insulation resistance of 1 kΩ...10 MΩ can be set independently of **Alarm 2**.

#### Menu item: Alarm 2

For **Alarm 2** an insulation resistance of 1 kΩ...10 MΩ can be set independently of **Alarm 1**.

#### Menu item: Fault memory

Automatic reset of inactive faults at the outputs relay 1, relay 2, digital output 1, digital output 2:

- **on** If a fault becomes inactive, the programmed outputs remain in fault condition until the system is reset manually.
- **off** If a fault becomes inactive, the programmed outputs automatically change their state.

### 8.2.1.2 DC alarm

The DC alarm is triggered in the event of a DC offset voltage  $U_{DC-E}$  in the system.

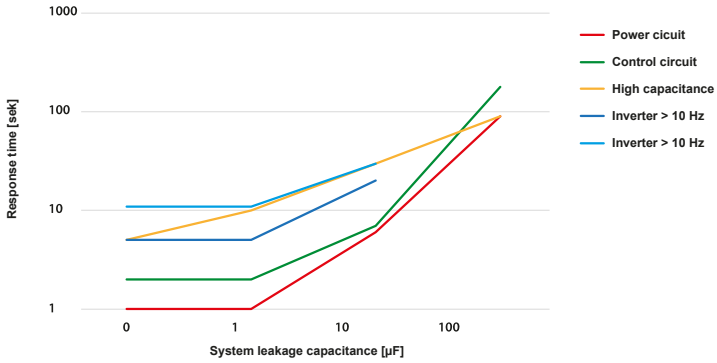

#### Menu item: Alarm

- **on** The DC alarm is triggered in the event of a DC offset voltage.
- **off** The DC alarm is NOT triggered in the event of a DC offset voltage.

#### Menu item: U(DC-E)

Set the DC alarm to a value between 20 V and 1 kV.

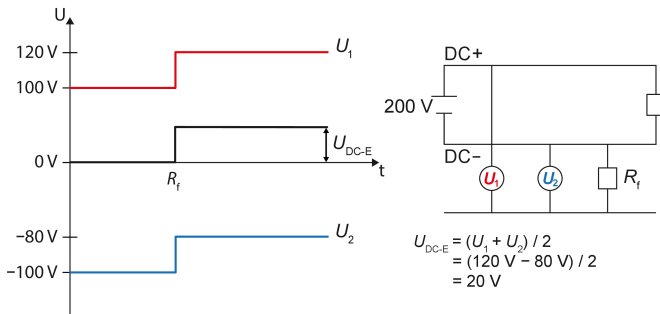

### 8.2.1.3 Profile

Adapt the area of application of the ISOMETER® to your system profile.

For a description of the profiles refer to "Device profiles", page 70.

The following can be selected:

- **Power circuits**            Suitable for most IT systems.
- **Control circuits**        Not recommended for voltages > 230 V.
- **Generator**                Fast measuring times, fast fault location possible.
- **High capacitance**        Suitable for systems with high system leakage capacitances.
- **Inverter >10 Hz**         Suitable for systems with dynamic frequency control by inverters in the range 10...460 Hz.
- **Inverter <10 Hz**         Suitable for systems with extremely low frequency controls in the range 0.1...460 Hz.
- **Customer-specific**      Enables the Bender service to make customer-specific settings.

### 8.2.1.4 System type

Adapt the ISOMETER® to the IT system to be monitored. The following can be selected:

- **DC**                        Direct current system
- **AC**                        Single-phase AC system
- **3AC**                      Three-phase AC system

### 8.2.1.5 Coupling

You can use the Bender coupling devices to adapt the ISOMETER® for use in systems with higher nominal system voltages  $U_n$ . For a description on the connection of coupling devices refer to the chapter "Coupling devices", page 64.

The following coupling devices can be selected:

- **none**                      No coupling devices are connected
- **AGH150W**                 $U_n$ : DC 0...1760 V, 3(N)AC 0...1150 V
- **AGH204S-AK80**          $U_n$ : AC 0...1300 V
- **AGH204S-AK160**        $U_n$ : AC 0...1650 V
- **AGH520S**                 $U_n$ : AC 0...7200 V
- **AGH676S-4**              $U_n$ : AC 12 kV

### 8.2.1.6 t(start)

The start-up delay  $t_{\text{start}}$  delays the start of the ISOMETER®'s first initial measurement.

Setting range:            0...600 s

### 8.2.1.7 Coupling monitoring

The ISOMETER® continuously monitors the coupling of energised systems. The coupling of deenergised systems is monitored at 8 hour intervals. This monitoring function can be activated or deactivated.

- **on**                        Coupling monitoring is activated.
- **off**                        Coupling monitoring is deactivated.

### 8.2.1.8 Behaviour when inactive

This menu item controls the behaviour of the device once it has been set to inactive.

- **Initial value** When the device becomes inactive, the maximum measured value of the measuring range is displayed and all insulation faults are reset.
- **Keep state** When the device becomes inactive, the maximum measured value and the insulation faults that were present at the time of the device deactivation are displayed.

### 8.2.1.9 Inputs

The ISOMETER® provides a total of three digital inputs.

The wiring diagram shows in an exemplary manner how the digital inputs can be wired.

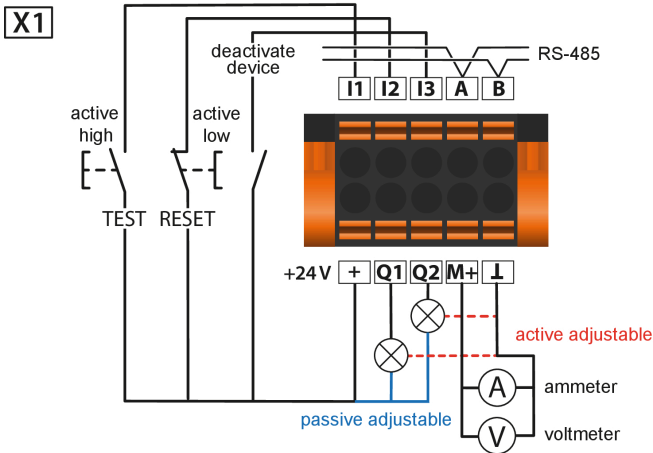

#### 8.2.1.9.1 Digital inputs 1 to 3

The following parameters are available for the configuration of the digital inputs 1 to 3.

## Menu item: Mode

### • Active high

An event is carried out on the rising edge of the digital input (low to high). Response time  $t(\text{on})$  /  $t(\text{off})$  after a switch-on signal.

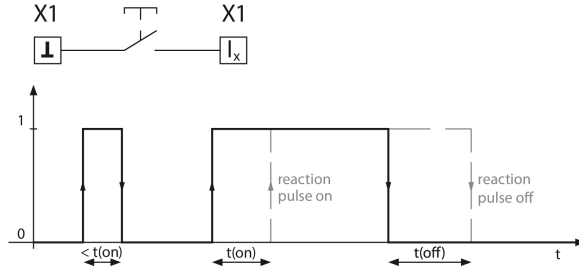

### • Active low

An event is carried out on the falling edge of the digital input (high to low). Response time  $t(\text{on})$  /  $t(\text{off})$  after a switch-off signal.

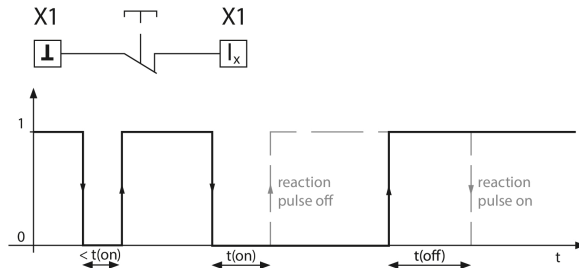

## Menu item: $t(\text{on})$

The response time  $t(\text{on})$  after a switch-on signal can be set from 100 ms to 300 s.

## Menu item: $t(\text{off})$

The response time  $t(\text{off})$  after a switch-off signal can be set from 100 ms to 300 s.

## Menu item: Function

You can configure the parameters of the ISOMETER®'s digital inputs for different functions:

- **off** Digital input without function
- **TEST** Starts device self test
- **RESET** Resets fault and alarm messages.
- **Deactivate device** The device does NOT measure the insulation resistance, the message **Device inactive** appears on the display. The IT system is NOT being monitored!
- **Start initial measurement** Discards all recorded measured values, and starts a new measurement.



### **Deactivation of the ISOMETER® with digital inputs**

The digital inputs are not interconnected. In order to avoid unintentional deactivation of the ISOMETER®, it should be ensured during configuration that different functions are assigned to the inputs.



### 8.2.1.10 Outputs

The ISOMETER® provides a total of six outputs (including buzzer). The following parameters can be set for the outputs:

#### 8.2.1.10.1 Relays 1 and 2

The following relay parameters can be set:

##### Menu item: TEST

The functional test of the relay can be activated or deactivated. This only applies to the manual test and not to the cyclic device self test:

- **on**            The manual test checks the switching function of the relay
- **off**            The manual test does not check the switching function of the relay

##### Menu item: Relay mode

The relay mode can be adapted to the application:

- **N/C**            N/C operation of the contacts 11-12-14 / 21-22-24  
(in fault-free condition, the alarm relay is energised).
- **N/O**            N/O operation of the contacts 11-12-14 / 21-22-24  
(in fault-free condition, the alarm relay is de-energised).
- **Flash**          The relay flashes. Flash rate: 1 s ON / 1 s OFF

##### Menu item: Functions 1 to 3

Up to 3 functions can be assigned to one output. The functions are linked to an OR operator:

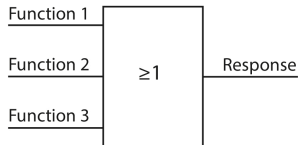

##### Selectable functions

Name in menu	Description
• <b>off</b>	The function is not used.
• <b>Ins. alarm 1</b>	The status of the output changes when the value falls below the set response value $R_{an1}$ .
• <b>Ins. alarm 2</b>	The status of the output changes when the value falls below the set response value $R_{an2}$ .

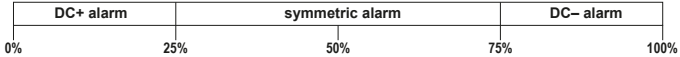
Name in menu	Description
• <b>Connection fault</b>	<p>The status of the output changes when one of the following connection faults occurs:</p> <ul style="list-style-type: none"> <li>• No low-resistance connection between the line conductors</li> <li>• No low-resistance connection between terminals E and KE to earth (PE)</li> <li>• Load at voltage output too low</li> <li>• Load at current output too high</li> <li>• Load on X1 too high</li> </ul>
• <b>DC– alarm</b>	<p>The status of the output changes in case of an earth fault in the direction of DC – when 75 % of the value is exceeded. This does not concern symmetrical faults. This function will only be carried out when the value falls below the response value <math>R_{an1}</math> and when the nominal system voltage is <math>U_n \geq 50</math> V.</p>
• <b>DC+ alarm</b>	<p>The status of the output changes in case of an earth fault in the direction of DC+ when 25 % of the value are exceeded. This does not concern symmetrical faults. This function will only be carried out when the value falls below the response value <math>R_{an1}</math> and when the nominal system voltage is <math>U_n \geq 50</math> V.</p>
• <b>Symmetrical alarm</b>	<p>The status of the output changes in the event of a resistance ratio between DC+ and DC– of 25 % to 75 %.</p> <div style="text-align: center;">  </div>
• <b>Device fault</b>	<p>The status of the output changes in the event of an internal device fault.</p>
• <b>Common alarm</b>	<p>The status of the output changes on the occurrence of any alarm or fault message. (Ins. alarms 1 &amp; 2, DC– / DC+ alarms, symmetrical alarm, connection and device errors)</p>
• <b>Measurement complete</b>	<p>The status of the output changes at the end of the initial measurement.</p>
• <b>Device inactive</b>	<p><i>Initial value:</i> When the device becomes inactive, the maximum measured value of the measuring range is displayed and all insulation faults are reset.  <i>Keep state:</i> When the device becomes inactive, the maximum measured value and the insulation faults that were present at the time of the device deactivation are displayed.</p>
• <b>DC offset alarm</b>	<p>The status of the output changes in the event of a DC shift voltage.</p>

### 8.2.1.10.2 Digital outputs 1 and 2

The following parameters can be set for each of the digital outputs:

#### Menu item: TEST

The functional test of the digital output can be activated or deactivated. This only applies to the manual test and not to the cyclic device self test:

- **on** The manual test changes the status of the digital output.
- **off** The manual test does not change the status of the digital output.

**Menu item: Mode**

The operating mode of the digital output has the following values:

- **Active** In active mode, +24 V are applied internally to output Qx.

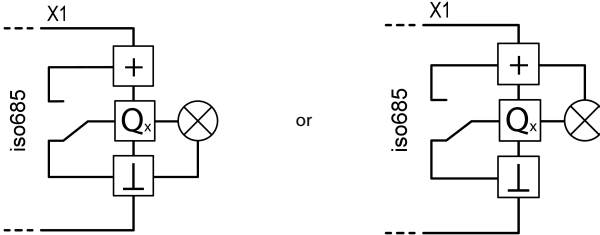

- **Passive** In passive mode,  $\leq 32\text{ V}$  are connected externally (see technical data). The output switches the applied potential to ground.

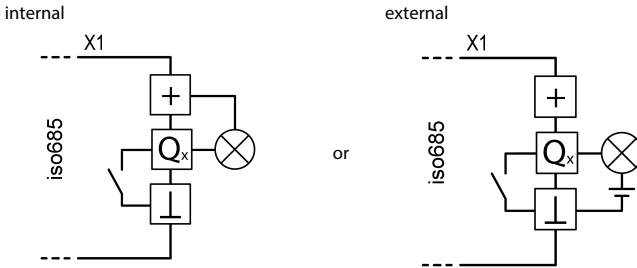

**Observe the maximum output current!**

Maximum output current in case of internal voltage supply via A1/+ and A2/-: 200 mA in total on X1. Also observe the formula for calculating  $I_{LmaxX1}$  in Inputs/outputs (X1).

**Menu item: Functions 1 to 3**

Up to 3 functions can be assigned to one output. The functions are linked to an OR operator:

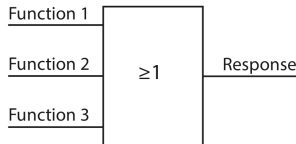

**Selectable functions**

Name in menu	Description
• <b>off</b>	The function is not used.
• <b>Ins. alarm 1</b>	The status of the output changes when the value falls below the set response value $R_{an1}$ .

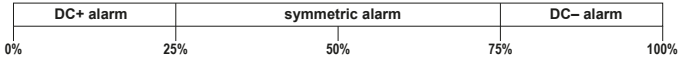
Name in menu	Description
• <b>Ins. alarm 2</b>	The status of the output changes when the value falls below the set response value $R_{an2}$ .
• <b>Connection fault</b>	The status of the output changes when one of the following connection faults occurs: <ul style="list-style-type: none"> <li>• No low-resistance connection between the line conductors</li> <li>• No low-resistance connection between terminals E and KE to earth (PE)</li> <li>• Load at voltage output too low</li> <li>• Load at current output too high</li> <li>• Load on X1 too high</li> </ul>
• <b>DC– alarm</b>	The status of the output changes in case of an earth fault in the direction of DC – when 75 % of the value is exceeded. This does not concern symmetrical faults. This function will only be carried out when the value falls below the response value $R_{an1}$ and when the nominal system voltage is $U_n \geq 50$ V.
• <b>DC+ alarm</b>	The status of the output changes in case of an earth fault in the direction of DC+ when 25 % of the value are exceeded. This does not concern symmetrical faults. This function will only be carried out when the value falls below the response value $R_{an1}$ and when the nominal system voltage is $U_n \geq 50$ V.
• <b>Symmetrical alarm</b>	The status of the output changes in the event of a resistance ratio between DC+ and DC– of 25 % to 75 %. <div style="text-align: center; margin-top: 10px;">  <p>0%                      25%                      50%                      75%                      100%</p> </div>
• <b>Device fault</b>	The status of the output changes in the event of an internal device fault.
• <b>Common alarm</b>	The status of the output changes on the occurrence of any alarm or fault message. (Ins. alarms 1 & 2, DC– / DC+ alarms, symmetrical alarm, connection and device errors)
• <b>Measurement complete</b>	The status of the output changes at the end of the initial measurement.
• <b>Device inactive</b>	<i>Initial value:</i> When the device becomes inactive, the maximum measured value of the measuring range is displayed and all insulation faults are reset. <i>Keep state:</i> When the device becomes inactive, the maximum measured value and the insulation faults that were present at the time of the device deactivation are displayed.
• <b>DC offset alarm</b>	The status of the output changes in the event of a DC shift voltage.

### 8.2.1.10.3 Buzzer

The following parameters can be set for the buzzer.

**Menu item: TEST**

The functional test of the buzzer can be activated or deactivated. This only applies to the manual test and not to the cyclic device self test.

- **on**            The manual test activates the buzzer sound.
- **off**            The manual test does not activate the buzzer sound.

**Menu item: Functions 1 to 3**

Up to 3 functions can be assigned to one output. The functions are linked to an OR operator:

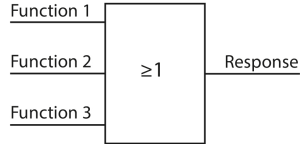
**Selectable functions**

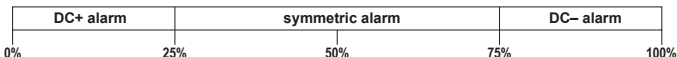
Name in menu	Description
• <b>off</b>	The function is not used.
• <b>Ins. alarm 1</b>	The status of the output changes when the value falls below the set response value $R_{an1}$ .
• <b>Ins. alarm 2</b>	The status of the output changes when the value falls below the set response value $R_{an2}$ .
• <b>Connection fault</b>	The status of the output changes when one of the following connection faults occurs: <ul style="list-style-type: none"> <li>• No low-resistance connection between the line conductors</li> <li>• No low-resistance connection between terminals E and KE to earth (PE)</li> <li>• Load at voltage output too low</li> <li>• Load at current output too high</li> <li>• Load on X1 too high</li> </ul>
• <b>DC– alarm</b>	The status of the output changes in case of an earth fault in the direction of DC– when 75 % of the value is exceeded. This does not concern symmetrical faults. This function will only be carried out when the value falls below the response value $R_{an1}$ and when the nominal system voltage is $U_n \geq 50$ V.
• <b>DC+ alarm</b>	The status of the output changes in case of an earth fault in the direction of DC+ when 25 % of the value are exceeded. This does not concern symmetrical faults. This function will only be carried out when the value falls below the response value $R_{an1}$ and when the nominal system voltage is $U_n \geq 50$ V.
• <b>Symmetrical alarm</b>	The status of the output changes in the event of a resistance ratio between DC+ and DC– of 25 % to 75 %.
	
• <b>Device fault</b>	The status of the output changes in the event of an internal device fault.

Name in menu	Description
• <b>Common alarm</b>	The status of the output changes on the occurrence of any alarm or fault message. (Ins. alarms 1 & 2, DC- / DC+ alarms, symmetrical alarm, connection and device errors)
• <b>Measurement complete</b>	The status of the output changes at the end of the initial measurement.
• <b>Device inactive</b>	<i>Initial value:</i> When the device becomes inactive, the maximum measured value of the measuring range is displayed and all insulation faults are reset. <i>Keep state:</i> When the device becomes inactive, the maximum measured value and the insulation faults that were present at the time of the device deactivation are displayed.
• <b>DC offset alarm</b>	The status of the output changes in the event of a DC shift voltage.

### 8.2.1.10.4 Analogue output

The analogue output can be configured using the following parameters:

#### Menu item: Mode

The operating mode of the analogue output has the following values:

##### Current output

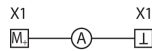

- **0-20 mA** Permissible load  $\leq 600 \Omega$
- **4-20 mA** Permissible load  $\leq 600 \Omega$
- **0-400  $\mu$ A** Permissible load  $\leq 4 \text{ k}\Omega$

##### Voltage output

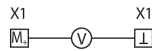

- **0-10 V** Permissible load  $\geq 1 \text{ k}\Omega$
- **2-10 V** Permissible load  $\geq 1 \text{ k}\Omega$

#### Menu item: Midscale

Select the appropriate midscale. The following parameters can be set:

- **Linear** The switching signal is linear to the insulation resistance in the indicated measuring range.

- **200 k $\Omega$**
- **400 k $\Omega$**

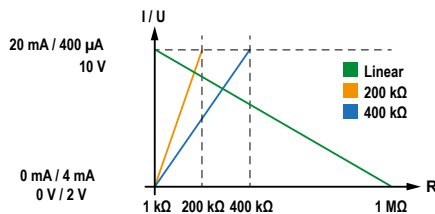

- 28 kΩ
- 120 kΩ

The switching signal is analogue to the midscale of 28 kΩ or 120 kΩ on a measuring instrument.

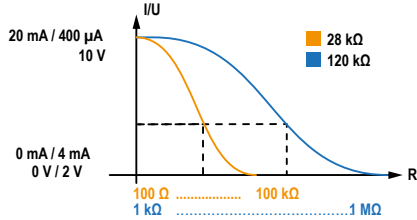
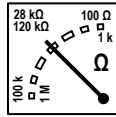

Calculation of the insulation resistance using the analogue output:

$$R_F = \frac{(A_2 - A_1) \cdot R_{SKM}}{A_3 - A_1} - R_{SKM}$$

$A_3$  = Measured value analogue output

$R_{SKM}$  = 28 kΩ or 120 kΩ / midscale

$R_F$  = Insulation fault in kΩ

Lower value, output $A_1$	Upper value, output $A_2$
0 mA	20 mA
4 mA	20 mA
0 μA	400 μA
0 V	10 V
2 V	10 V

**Menu item: TEST**

The functional test of the analogue output can be activated or deactivated. In this way, the analogue output is adjusted once for the entire range. This only applies to the manual test and not to the cyclic device self test:

- **on** The manual test checks the analogue output function.
- **off** The manual test does not check the analogue output function.

**Menu item: Function**

Select the appropriate setting for the analogue output. The following parameters can be set.

- **Insulation value** Depending on the measured insulation value, an analogue current or voltage signal is provided at the output.
- **DC offset** Depending on the measured DC offset, an analogue current or voltage signal is provided at the output. This setting can only be used when **Linear** is selected in the menu **Midscale**.

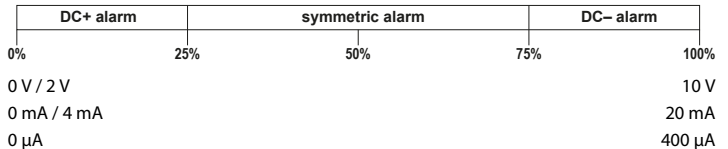

## 8.2.2 Data meas. values

The ISOMETER® stores certain measured values for a specific period of time. You can view these data in the **Data meas. value** menu. Navigate through the different views using the  $\wedge$  and  $\vee$  buttons:

- **Data - isoGraph**                      Displays the insulation resistance in chronological sequence  
Scaling:
  1. hour
  2. day
  3. week
  4. month
  5. year
- **Data - Insulation**                      Displays the current insulation resistance, the minimum insulation resistance measured and the system leakage capacitance.
- **Data - IT system**                      Displays the system phase-to-phase voltages and the mains frequency (r.m.s. values)
- **Data - IT system**                      Displays the system phase-to-earth voltages

## 8.2.3 Control

Controlling the device during operation:

- **TEST**                                      Start device test.
- **Reset**                                      Reset alarm and error messages.
- **Start initial measurement**              Discard measured values and start a new measurement.
- **Device**                                      Set the ISOMETER® insulation resistance measurement function to active or inactive:
  - **Active:** The device is active.
  - **Inactive:** The device does NOT measure the insulation resistance, the message **Device inactive** appears on the display. The IT system is not monitored!

## 8.2.4 History

In the history menu, the faults detected by the ISOMETER® are displayed. For a detailed description refer to "History memory", page 33.

- **History**                                      Overview of faults that have occurred
- **Delete**                                      Resets the history memory

## 8.2.5 Device settings

Here you can make the basic settings of the ISOMETER®.

### 8.2.5.1 Language

You can select the following display languages:

- **Deutsch**
- **English (GB)**
- **Español**
- **Français**
- **Norsk**
- **Polski**
- **Português**



### 8.2.5.2 Clock (& Date)

Setting the time and date in the device.

- **Time**

Setting the current time.

- **Time format**

Setting the time format.

- 12 h** 12-hour notation am/pm
- 24 h** 24-hour notation

- **Summer time**

Setting the mode for the change between summer and winter time.

- off** No automatic change between summer time and standard time
- DST** Daylight Saving Time  
Automatic time change according to North American Regulation:  
Start: Second Sunday in March from 2:00 a.m. local time to 3:00 a.m. local time.  
End: First Sunday in November from 3:00 a.m. local time to 2:00 a.m. (local time)
- CEST** Central European Summer Time  
Automatic time change according to Central European Regulation:  
Start: Last Sunday in March from 02:00 a.m. CET to 03:00 a.m. CEST.  
End: Last Sunday in October from 03:00 a.m. CEST to 02:00 a.m. CET.

- **Date**

Setting the current date.

- **Date format**

Setting the format of the displayed date.

- dd.mm.yy** day, month, year
- mm-dd-yy** month, day, year

- **NTP**

Switching time synchronisation via NTP server on or off.

- **NTP server**

Entering the IP-address of the NTP server.

- **UTC**

Setting the time per UTC (coordinated universal time).

Winter time, Germany = (UTC) +1; Summer time, Germany = (UTC) +2

### 8.2.5.3 Interface

Menu for the connection of further devices to the ISOMETER® and their configuration

#### Menu item: Write access

Configure whether the parameters of the device can be set externally via Modbus or the web server. Displaying and reading out data is not affected by this setting.

- **Allow** Allow external parameter setting
- **Deny** Deny external parameter setting

## Menu item: Ethernet

Set the parameters for communication with other devices via the Ethernet interface. Communication with Modbus, web server and BCOM is possible.

- **DHCP**                      Activates and deactivates the automatic address setting via DHCP server.  
**on:** IP address, subnet mask and standard gateway are assigned automatically.  
**off:** Automatic IP address assignment is deactivated. Addresses are set manually. (See the following items)  
                                     The current IP address of the device is shown in the menu **Info**.
- **IP**                              *Manual entry*<sup>1)</sup> of IP address
- **SN**                              *Manual entry*<sup>1)</sup> of sub net mask. Standard subnet mask: 255.255.255.0
- **Std.GW**                      *Manual entry*<sup>1)</sup> of standard gateway (router) address  
                                     If there is no standard gateway in the local network, enter an address not yet used in the local address range as gateway address. The device cannot be accessed via Ethernet without a standard gateway address.
- **DNS**                              *Manual entry*<sup>1)</sup> of the DNS server address
- **Domain**                      *Manual entry*<sup>1)</sup> of the domain name

1) The manual entries must be made in the respective address range of the local network. Information on the current configuration of the local network is available from the administrator responsible for this network.

## Menu item: BCOM

Settings for communication with other devices via BCOM.

- **System name**              Entering the system name for the network in which the devices are located. All devices that communicate in one BCOM network must have the same system name.
- **Subsystem**                Entering the BCOM subsystem address. The devices can communicate with devices in subsystems with the same or a different subsystem address.
- **Device address**        Entering the device address. Within one BCOM network every device must have a different address so that it can be distinguished from other devices in the system and communicate correctly.
- **Timeout**                    Setting a timeout for messages between 100 ms ... 10 s. This time specification defines the maximum permissible time for a device to respond.
- **TTL for subscription**    This time of 1 s ... 1092 min defines the intervals at which the ISOMETER® sends messages to e.g. a gateway. Severe alarms (e.g. insulation alarms or substantial value changes) are always sent immediately.

## Menu item: Modbus TCP

Activation and deactivation for the communication with other devices via Modbus TCP.

- **Port 502**                    **on:** Modbus TCP can be used for communication with other devices  
**off:** Modbus TCP cannot be used for communication with other devices

### Menu item: RS-485

Set the parameters for communication with other devices via the Bender sensor bus.

- **Mode** Selecting the RS-485 protocol
- **BS bus** Setting the BS bus address in the range: 1...90
- **isoData** Settings for isoData modes: 1, 2 or 3
- **Modbus RTU** Settings for the Modbus RTU protocol
  - Address: entering an address from 1...247
  - Baud rate: 9.6 | 19.2 | 37.4 | 57.6 | 115 kBd
  - Parity: even | odd | none
  - Stop bits: 1 | 2 | auto

### 8.2.5.4 Display

You can adjust the display brightness for the ISOMETER® in the **Display** menu:

#### Menu item: Brightness

Adjust the display brightness between 0 % and 100 % in steps of 10.

If no button is pressed on the display for 15 minutes, the brightness of the display is reduced. Then, when a button is pressed, the original brightness is restored.

#### Menu item: Automatic dimming

- **on** Background lighting, **POWER** LED and button lighting are switched off after 3 min without operation and are only switched on again when any button is pressed. The alarm LEDs light in the event of an alarm.
- **off** Background lighting, **POWER** LED and button lighting are switched on permanently.

### 8.2.5.5 Password

The password function permits protecting device parameters against unauthorised changes.

#### Menu item: Password

Entering the four-digit device password. The default password is 0000.

#### Menu item: Status

Decide whether the password query should be used:

- **on** Password query active
- **off** Password query inactive

### 8.2.5.6 Commissioning

In the menu **Commissioning** you can reopen the ISOMETER®'s commissioning wizard. Pressing the commissioning button immediately starts the commissioning wizard.

After going through all the queried values, the new values are accepted by the device. Press **ESC** to abort the process.

### 8.2.5.7 Backup

In the **Backup** menu, device settings can be saved or device settings already saved can be restored.

- **Save**                      The ISOMETER® saves your device settings.
- **Restore**                    The ISOMETER® restores your initial or your saved device settings.

### 8.2.5.8 Approve

Activation of special customer profiles by Bender.

The device is first configured by the Bender service and the configuration is saved in a service profile.

Activating this profile causes a warning message. The customer can activate it as a customer-specific profile by entering a *Service Profile PIN*. The warning message is then eliminated.

- **Profile**                      Enter a 4-digit Service Profile PIN

### 8.2.5.9 Factory settings

Resetting the device to factory settings.

### 8.2.5.10 Software

Functions for updating the device software. The current software version is displayed in the **Info** menu.

- **Update via interface**      Activates the SW update via web interface.
- **Update**                      Starts update on the device. Alternatively, the update can also be started via the web interface.

#### Menu item: Update via interface

This function must be active if a software update is to be transferred from the web interface to the device via a BUF file.

#### Menu item: Update

Starts the update process after the BUF file has been transferred to the device. Alternatively, the update can also be started via the web interface.

### 8.2.5.11 Service

The service menu is accessible only by Bender Service.

## 8.2.6 Info

The ISOMETER®'s present settings can be viewed in the **Info** menu. Navigate through the different views using the  $\wedge$  and  $\vee$  buttons:

- **Device**                      Device name, serial number, article number
- **Software**                    Software version of measuring instruments, software version of HMI
- **Measurement**              Selected profile, selected system type
- **Clock**                      Time, date, summer time
- **Ethernet**                    IP address, DHCP status, MAC address
- **RS485**                      BS bus address, Modbus RTU address, BS bus mode

## 9 Device communication

### 9.1 Ethernet interface

The Ethernet interface can be used for the communication with BCOM, Modbus TCP, and web server.

**i** *A maximum of 5 TCP/IP connections can be used simultaneously.*

### 9.2 BCOM

BCOM is intended for communication between Bender devices via Ethernet.

In order to guarantee that all devices are able to communicate via BCOM, all devices must have the same system name. Devices can be organised in subsystems. Each device requires an individual device address.

For more information regarding BCOM, refer to the BCOM manual (D00256) at <https://www.bender.de/en/service-support/download-area/>.

**i** *When address 0 has been set for communication via BCOM, the device can be accessed via the network (e.g. for parameter setting, etc.) but it cannot communicate with other devices.*

### 9.3 Modbus TCP

Modbus is an internationally widely used protocol for data transfer between devices. Modbus TCP (Transmission Control Protocol) is implemented on the connection-oriented and packet-switched TCP protocol. This allows Modbus instructions to be transmitted via any Internet-capable connection.

Measured values, messages and parameters are stored in virtual register addresses. Data can be read out with a read command written to a register address. With a write command, data can be written into a register address. The register addresses of the individual measured values und parameters can be found in the manual "iso685-D Annex A" with the title "ISOMETER® iso685 device family - Modbus settings" at <https://www.bender.de/en/service-support/download-area/>

**i** *For setting device parameters externally via Modbus, the menu item **Allow** must be set in the **Write access** menu.*

### 9.4 Web server

The ISOMETER® devices of the isoxx685 family have an integrated web server which displays the device data on a web browser. This enables you to read out the measured values of the ISOMETER® devices and set parameters.

Preferably use the following browsers:

- Google Chrome
- Mozilla Firefox
- Microsoft Edge

The web server is accessed by entering the IP address of the ISOMETER® in the web browser. (Example: <http://192.168.0.5>). You can find the current IP address of the respective ISOMETER® in the device menu:

**MENU: Info > Ethernet**

## 9.4.1 Conventions



### **TCP connections**

*A maximum of 5 TCP/IP connections can be used simultaneously. Only **one** device may access the web server at the same time. If several devices try to access the web server it may result in timeouts.*



### **Write access**

*The write access is deactivated by default in the device menu (= **Deny**). In order to change parameters via the web server, write access must be allowed under*

**MENU: Device settings > Interface > Write access**

## 9.4.2 Functions

The web server offers the following functions:

- Visualisation
  - Display of device information (e.g. device type, software version, etc.)
  - Indication of current device settings
  - Indication of alarm messages
  - Indication of the Modbus information of the individual parameters
  - Indication of the interfaces in use
  - Overview of the current measured values
  - Detailed graphic representation of the insulation resistance (isoGraph)
  - Fast and easy visualisation, no programming knowledge required
- Parameter setting
  - Easy and fast setting of the device parameters
  - Easy assignment of and editing options for device texts
- Maintenance
  - Data storage of specific events for fast support by Bender Service

### 9.4.3 User interface

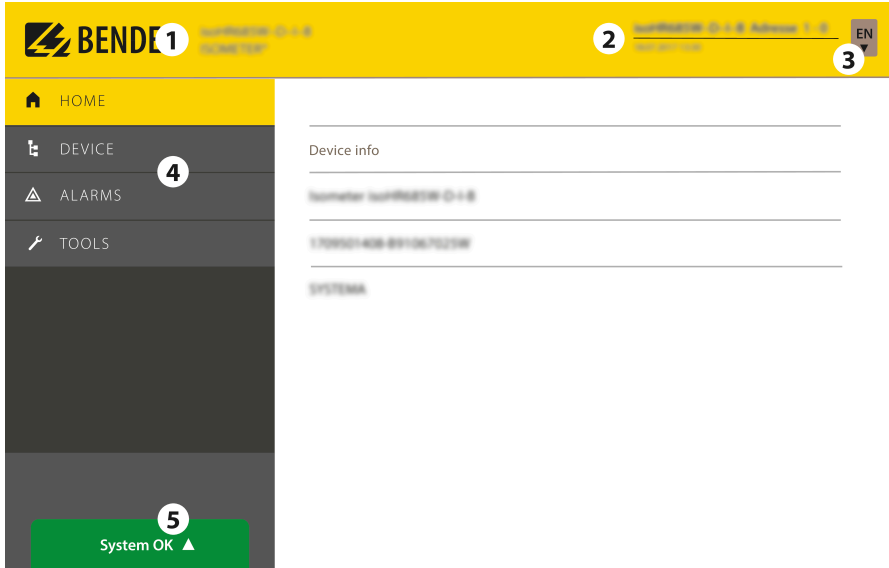

1	LOGO	Logo and device name
2	System information	<p>Device address                  Date and time of the accessing browser system.                  The web user interface does not show the current time of the ISOMETER®.                  The current time of ISOMETER® the can be determined in the menu at  <b>DEVICE &gt; Settings &gt; Clock</b></p>
3	Language	Changing the language settings
4	Browser menu	<p>Main menu of the web server (first level)</p> <ul style="list-style-type: none"> <li>• START</li> <li>• DEVICE</li> <li>• ALARMS</li> <li>• e.g. TOOLS, PARAMETER ADDRESSES (device-dependent)</li> </ul>
5	System message	<p>If there are pending alarms, click on the red button or go to menu point <b>ALARMS</b> to obtain further information.</p> <div style="display: flex; flex-direction: column; align-items: center;"> <div style="background-color: #008000; color: white; padding: 5px; margin-bottom: 10px;">System OK ▲</div> <div style="background-color: #800000; color: white; padding: 5px;">Alarms 2 ▲</div> </div>

### 9.4.4 Menu structure

The web menu is located at the left side of the browser window. Activated menu items are either highlighted in yellow or are written in yellow. Use the scroll bar on the right side to display further menu items.

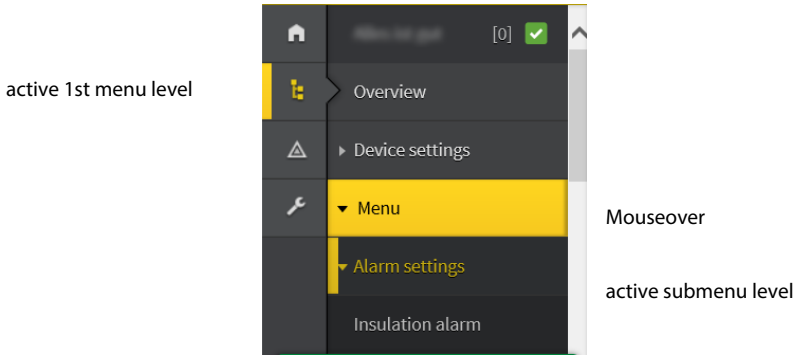

The menu structure is provided by the respective selected device. It is different depending on the respective device and on its menu structure. The structure of the device menu is described in the manuals of the respective device variants in the chapter “Settings”.

#### **i** Web menu – device menu

*Web menu: Menu displayed by the web server via the browser.*

*Device menu: Menu available via the display on the device.*

### 9.4.5 Parameter changes

Inputs are located horizontally (orange frame) and the corresponding parameters vertically (blue frame). Currently set parameters are placed on the left side of the input field in grey font (red frame) and also appear in the entry field, provided that no change has been made.

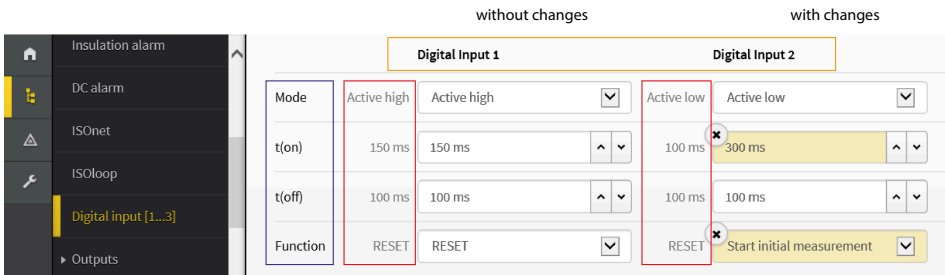

Figure: Display of the present values in a browser (cutout)



## Error detection in case of incorrect entry

In some cases the system expects certain characters to be entered, for example, CAPITAL LETTERS. In case of an incorrect entry, the corresponding input field is coloured in red.

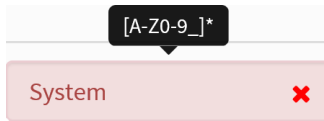

Figure: Incorrect text entry

## Display of parameters with Modbus registers

To each parameter a Modbus register is assigned that can be addressed via the open interfaces Modbus TCP or Modbus RTU. These registers with their corresponding parameters can be displayed. Displaying them is activated via the menu: **TOOLS > Parameter addresses**.

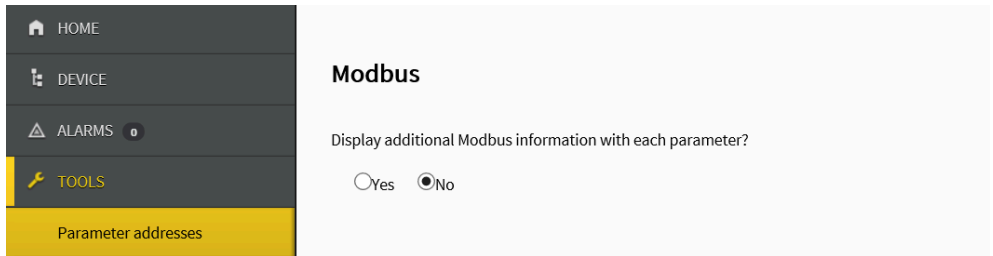

Figure: Activating the Modbus register display

Once the display has been activated, all parameters are shown with their corresponding Modbus registers.

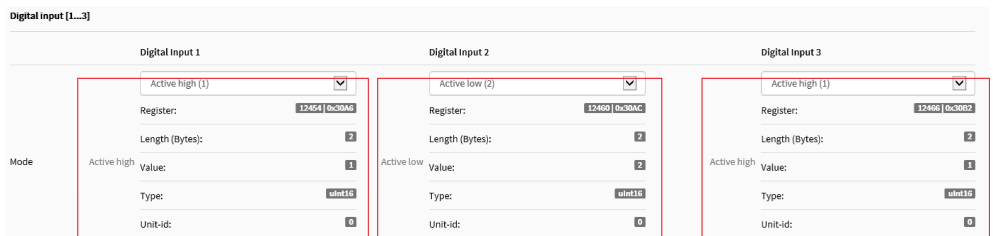
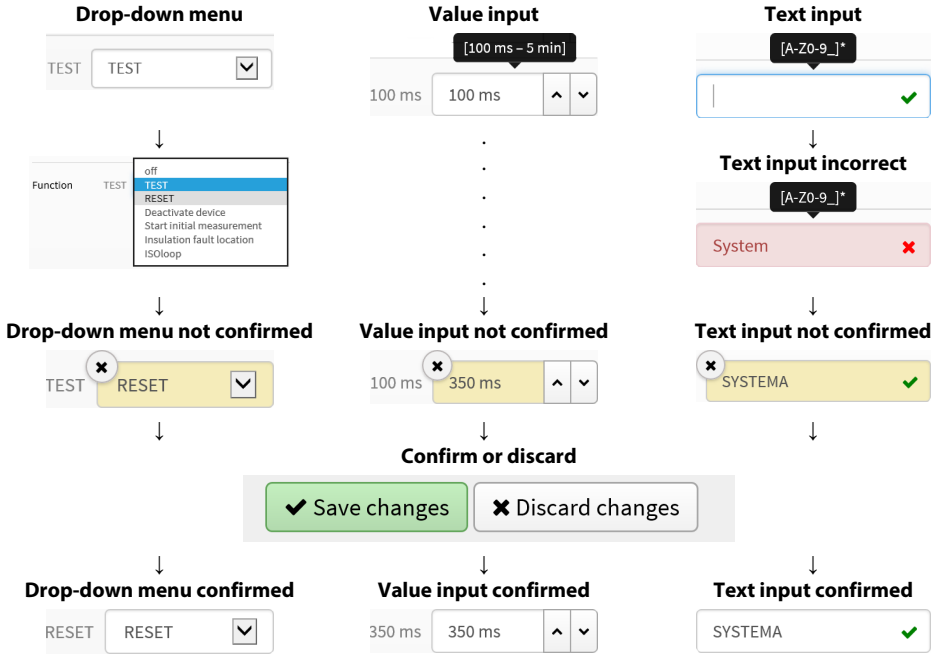

Figure: Display of Modbus registers

### 9.4.6 Changing parameters in a web browser

Changed values are highlighted in yellow in the input field. Changes can be made via drop-down menu, value input or text input.

The following figure shows application examples.



Possibilities of making entries via a web interface in iso685 devices

### 9.4.7 Changing parameters in the device menu when the web browser is open

When values are changed in the device menu of an iso685 device, these changed values are not automatically displayed on an already open browser page in the web server. The values that have been changed in the device menu, are highlighted in yellow on the web server, but the previously set value is still displayed.

**i** **Update of changes**

*When a new browser page is called up, the changes are already updated.*

You have two options:

- You want to confirm the values changed on the device and that the web server displays the updated changes: To this end, click on the button **Save changes** at the lower edge of the screen.
- You do NOT want to confirm the values that were changed on the device. You want to restore the values set before the change and to discard the changes made via the device: To this end, click on the button **Discard changes** at the bottom of the screen.

## 9.4.8 Write access for parameter changes

You can deny the web server the write access for the ISOMETER® iso685, for example in order to prevent parameter changes via the web server.

You can deny write access in the menu or directly on the web server. If you want to allow write access again, you can only do so on the device itself.

**MENU: Device settings > Interface > Write access**

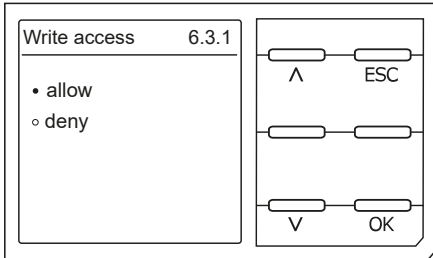

Factory set to **Deny**: A parameter change via the web server is only possible if you allow write access in the device.

## 9.5 BS bus

The BS bus is used to extend Bender measuring devices (e.g. ISOMETER®). It is an RS-485 interface with a specially developed protocol for Bender devices. On the BS bus, the transmission of alarm messages takes priority over the transmission of all other messages. For further information, refer to the BS bus manual (document number: D00278) at

<https://www.bender.de/en/service-support/download-area/>



### CAUTION

*When using interface converters, a galvanic separation is required.*



*The compatibility of the BS bus and the BMS bus is restricted!*

### 9.5.1 Master-slave principle

The BS bus works according to the master-slave principle. The measuring device operates as the master, while all sensor devices operate as slaves. The master is responsible for the communication that is necessary for the measuring function. It also provides the required bus bias voltage for the operation of the BS bus.

### 9.5.2 Addresses and address ranges on the BS bus

Address 1 is assigned to the master. All sensor devices receive unique addresses starting with address 2, assigned in consecutive order without gaps. In the event of a device failure, a maximum gap of 5 addresses is permissible.

### 9.5.3 RS-485 specifications and cables

The RS-485 specification restricts the cable length to 1200 m and requires a daisy chain connection. The number of devices on the BS bus is only limited by the BS bus master.

Use twisted pair, shielded cables for bus cabling. For example, cable type J-Y(St)Y n × 2 × 0.8 is suitable. The shield must have a single-ended connection to earth. The BS bus must be terminated at both ends with terminating resistors (120 Ω, 0.25 W). The terminating resistors are connected in parallel to the terminals A and B. Some devices feature integrated terminating resistors and can be activated or deactivated via the **R** button.

### 9.5.4 Cable routing

The optimum cable routing for the BS bus is a double-terminated bus topology. The length of the branch line is limited to 1 m. These branch lines do not have to be terminated.

Bus topology examples:

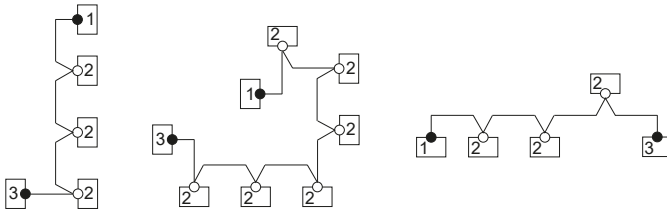

#### Termination

- 1 Master** Terminating resistor activated via switch on device (ON) or external terminating resistor between terminals A and B
- 2 Slave** Terminating resistor deactivated via switch on device (OFF)
- 3 Slave** Terminating resistor activated via switch on device (ON) or external terminating resistor between terminals A and B



#### ADVICE

Only the first and last device in one line may be terminated. Therefore, check all devices.

## 9.6 Modbus RTU

Modbus RTU is implemented on the RS-485 interface. The data transmission is binary/serial. Error-free and continuous data transmission must be guaranteed.

Measured values, messages and parameters are stored in virtual register addresses. Data can be read out with a read command written to a register address. With a write command, data can be written into a register address. The register addresses of the individual measured values and parameters can be found in the manual “iso685-... Modbus settings” at

<https://www.bender.de/en/service-support/download-area/>

## 9.7 isoData protocol

Data transmission is continuously carried out and can neither be interrupted by the data slave station nor be influenced in any other way (unidirectional). This protocol cannot be used in combination with the BMS protocol.

To evaluate the data by means of a PC or laptop, an USB/RS232-RS485 interface converter is required. Contact Bender Service to receive it.

Interface data:

- RS-485 interface galvanically separated from the device electronics
- Connection to terminals **A** and **B**.
- Maximum cable length 1200 m (in Mode 1)
- A data block is output after each valid measurement

Mode	Mode 1	Mode 2	Mode 3
<b>Baud rate</b>	9600	115200	115200
<b>Data Bits</b>	8	8	8
<b>Stop bits</b>	1	1	1
<b>Parity</b>	None	Even	Even
<b>Flow control</b>	None	None	None
<b>TX Interval [ms]</b>	10 * 1000	1000	1000
<b>Bitmask support</b>	No	No	Yes
<b>Frame counter support</b>	No	Yes	Yes
<b>Field delimiter</b>	0x0F	';' (0x3B)	';' (0x3B)
<b>Start token</b>	0x02	!''	!''
<b>End token</b>	0x03	n/a	n/a
<b>Line end</b>	<LF><CR>	<CR><LF>	<CR><LF>

**i** *The elements described in the table below have a defined length in the present implementation. However, isoData is a protocol that separates individual elements by means of delimiters (see **Field delimiter** in the table above). When these delimiters are used, a defined field length can basically be dispensed with. It is strongly recommended to implement external applications NOT based on field lengths, but based on element separators.*

### isoData protocol table

Description	Length [Bytes]	Values	Unit	Example string	Position in data block		
					Mode 1	Mode 2	Mode 3
Data packet start character for Modes 2 and 3	1	!		!	-	0	0
Data packet start character for Mode 1	1	0x02 (control character = STX = Start of Text)		0x02	0	-	-
Available bitmask	8	Dependent on the fields included. (Bitmask)		FFFFFFFF	-	-	1
Date	8	Current device date		dd.mm.yy	-	-	2
Time	12	Current device time		hh:mm:ss:mmm	-	-	3

Description	Length [Bytes]	Values	Unit	Example string	Position in data block		
					Mode 1	Mode 2	Mode 3
Insulation fault location	1	'-' = symmetrical fault '+' = fault on L1/+ '-' = fault on L3/-		x	-	1	-
Insulation fault location Detailed overview	4	Insulation fault percentage distribution from -100 ... +100	%	+123	-	8	4
Insulation fault location Brief overview	1	0 = AC fault 1 = DC- fault 2 = DC+ fault	kΩ	0	6	-	-
Insulation resistance Brief overview	6	$R_f$	kΩ	123456	1	-	-
Insulation resistance Limited overview	6	$R_f$ Note: Value limited to 9.9 MΩ	kΩ	1234.5	-	2	-
Insulation resistance Detailed overview	9	$R_f$ Note: Value limited to 9.9 MΩ		1234567.8	-	-	5
Measured value counter	2	Increased with each new measured value Integer with overflow at 99.	μF (R Mode) nF (Z Mode)	12	-	11	6
Leakage capacitance $C_g$	4	R Mode [μF] Z Mode [nF] Note: Z Mode is not supported	V	1234	-	3	7
Voltage $U_n$ (VRMS) L1-L2	7	Voltage between phases L1 and L2 RMS values, unsigned	V	12345.6	-	-	8
Voltage $U_n$ (VRMS) L1-L3	7	Voltage between phases L1 and L3 RMS values, unsigned	V	12345.6	-	-	9
Voltage $U_n$ (VRMS) L2-L3	7	Voltage between phases L2 and L3 RMS values, unsigned	V	12345.6	-	-	10
Voltage $U_n$ (VRMS)	5	Voltage between phases L1 and L2 RMS values AC system sign '-' DC system sign always '+'	V	+1234	-	5	-
Voltage $U_n$ (VRMS) L1-PE	5	Voltage between phase L1 and PE RMS values, Note: Sign always '+'	V	1234	-	6	11
Voltage $U_n$ (VRMS) L2-PE	5	Voltage between phase L2 and PE RMS values, Note: Sign always '+'	V	1234	-	-	12
Voltage $U_n$ (VRMS) L3-PE	5	Voltage between phase L3 and PE RMS values, Note: Sign always '+'	V	1234	-	7	13
Measurement quality	3	Quality of measured value 0 % = poor quality => change profile 100 % = good quality => profile matches application	%	100	-	-	14
Voltage DC-PE	4	DC offset voltage to earth	V	+123	-	-	15
Alarm messages	4	[Hexadecimal] (without leading "0x") The alarms are included in this value with the OR function.	BIT	1234	-	10	16
Bit 2: Device error	n/a	0x0002		Bitmask	-	+	+
Bit 3: Prewarning Insulation resistance $R_f$ on L1/+	n/a	0x0004		Bitmask	-	+	+
Bit 4: Prewarning Insulation resistance $R_f$ on L2/-	n/a	0x0008		Bitmask	-	+	+
Bit 5: Prewarning Insulation resistance $R_f$ sym.	n/a	0x000C		Bitmask	-	+	+
Bit 6: Alarm Insulation resistance $R_f$ on L1/+	n/a	0x0010		Bitmask	-	+	+
Bit 7: Alarm Insulation resistance $R_f$ on L2/-	n/a	0x0020		Bitmask	-	+	+
Bit 8: Alarm Insulation resistance $R_f$ sym.	n/a	0x0030		Bitmask	-	+	+

Description	Length [Bytes]	Values	Unit	Example string	Position in data block		
					Mode 1	Mode 2	Mode 3
Bit 9: Prewarning Insulation impedance $Z_F$	n/a	0x0040 Note: Currently not supported		Bitmask	-	+	-
Bit 10: Alarm Insulation impedance $Z_F$	n/a	0x0080 Note: Currently not supported		Bitmask	-	+	-
Bit 11: Alarm Undervoltage $U_n$	n/a	0x0100 Note: Currently not supported		Bitmask	-	+	-
Bit 12: Alarm overvoltage $U_n$	n/a	0x0200 Note: Currently not supported		Bitmask	-	+	-
Bit 13: System test message	n/a	0x0400		Bitmask	-	+	+
Bit 14: Device start with alarm	n/a	0x0800 Note: Currently not supported		Bitmask	-	+	-
Alarm message: insulation fault Brief overview	1	0 == No alarm 1 == Alarm 1 2 == Alarm 2 3 == Alarm 1 + Alarm 2	Number	0	5	-	-
Temperature in the device	4	Device temperature preceded by '+' or '-' sign	°C	+100	-	-	17
System frequency	3	0	Hz	123	-	-	18
Response value 1	6	$R_F$ Note: For response values $\geq 1 \text{ G}\Omega$ , '999999' is output	k $\Omega$	123456	2	-	19
Response value 2	6	$R_F$ Note: For response values $\geq 1 \text{ G}\Omega$ , '999999' is output	k $\Omega$	123456	3	-	20
System type	3	[ ' DC'   ' AC'   '3AC' ] ATTENTION: Observe the blank space preceding AC and DC!		3AC	-	-	21
Relays (K1,K2), states	1	0 -> K1 == off, K2 == off 1 -> K1 == on, K2 == off 2 -> K1 == off, K2 == on 3 -> K1 == on, K2 == on		0	4	-	22
Impedance	6	$Z_F$	k $\Omega$	1234.5	-	4	-
Unsymmetrical insulation resistance, approximated	6	$R_{UGF}$	k $\Omega$	1234.5	-	9	-
Insulation measurement ADC value	5	ADC value in digits		12345	-	-	-
Active measuring profile	2	01 - Power circuits 02 - Control circuits 03 - Generator 04 - High capacitance 05 - Inverter > 10Hz 06 - Inverter < 10Hz 07 - Customer-specific profile 08 - Service profile	Number	01	-	-	23
Frame counter	1	Counts continuously from 0 to 9.		1	-	-	24
String end	2	String end! ATTENTION: Standard mode sends <LF><CR> i. e. the two characters are in reverse order.		<CR><LF>	+	+	+

## 10 Coupling devices

Coupling devices extend the nominal system voltage range of an ISOMETER®. Depending on the configuration, systems up to a nominal system voltage of 12 kV can be monitored.



### **DANGER Risk of electric shock!**

*Coupling devices are operated with high voltage, which can be life-threatening in case of direct contact. Make sure that only electrically skilled persons work on or with the device. Read the operating manual of the coupling device carefully.*



*In systems with a nominal system voltage of more than 690 V and with overvoltage category III, a fuse for the connection to the system to be monitored must be provided. We recommend 2 A fuses.*

### System behaviour

- If the ISOMETER® is operated with a coupling device, this device must be specified in the commissioning assistant during commissioning or in the device menu later on.
- If a coupling device is selected during commissioning or in the device menu, the ISOMETER® automatically sets the system type to 3AC. This setting must not be changed.
- If the ISOMETER® is operated with a coupling device, the DC alarm and the coupling monitoring are deactivated.
- If the ISOMETER® is operated with a coupling device, the values of the coupling monitoring, the DC offset and the measured voltage values are not determined correctly.

### 10.1 Connection using the AGH150W-4 (Art. No.: B98018006)

#### Connection to a DC system

Nominal voltage:

DC 0...1760 V

Relative uncertainty:

15 % min. +/- 5 kΩ

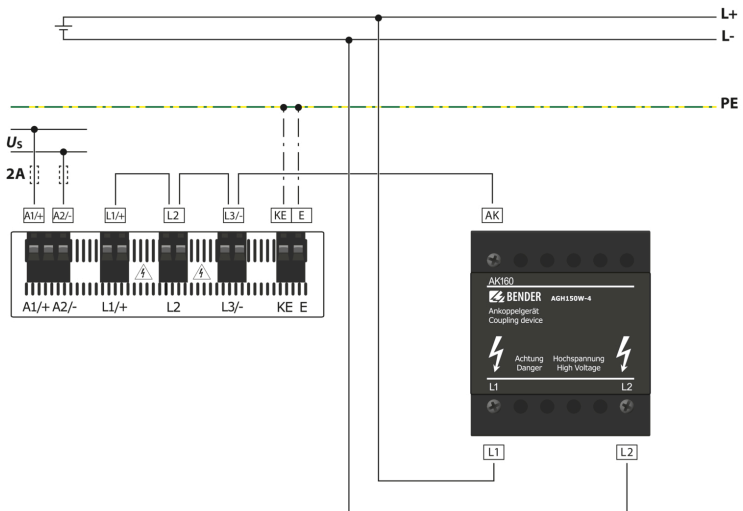



### Connection to a 3NAC system

Nominal voltage:  
**3NAC 0...1150 V**  
 Relative uncertainty:  
 15 % min. +/- 5 kΩ

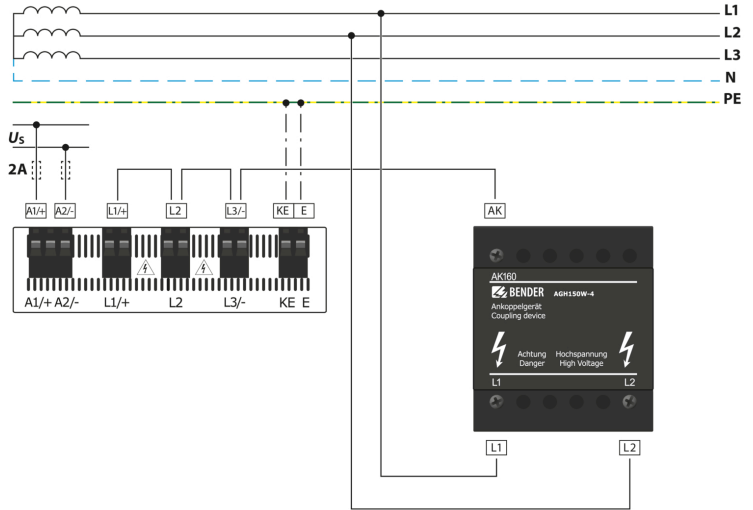

## 10.2 Connection using the AGH520S (Art. No.: B913033)

### Connection to a 3AC system

Nominal voltage:  
**AC 0...7200 V**  
 Relative uncertainty:  
 15 % min. +/- 5 kΩ

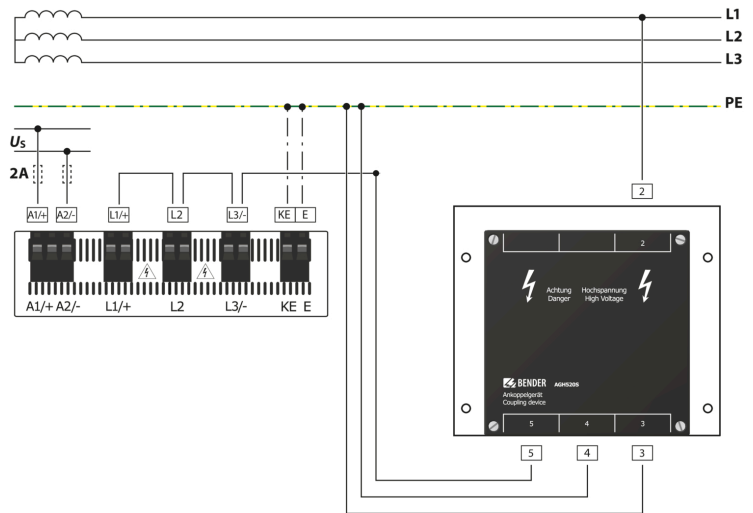

## Connection to a 3NAC system

Nominal voltage:

AC 0...7200 V

Relative uncertainty:

15 % min. +/- 5 k $\Omega$

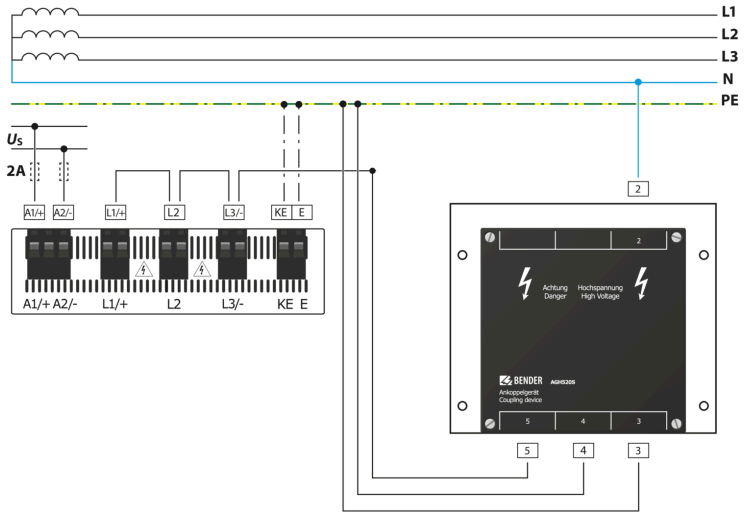

## 10.3 Connection using the AGH204S-4 (Art. No.: B914013)

### Connection to a 3(N)AC system

Nominal voltage with rectifier:

AC 0...1300 V

Nominal voltage without rectifier:

AC 0...1650 V

Relative uncertainty:

15 % min. +/- 5 k $\Omega$

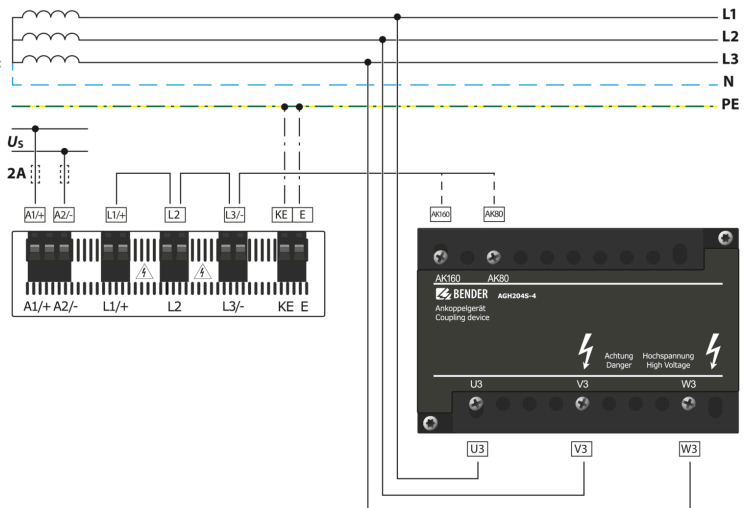

### 10.4 Connection using the AGH676S -4 (Art. No.: B913055)

#### Connection to a 3(N)AC system

Nominal voltage:  
 AC 12 kV  
 Relative uncertainty:  
 15 % min. +/- 5 kΩ

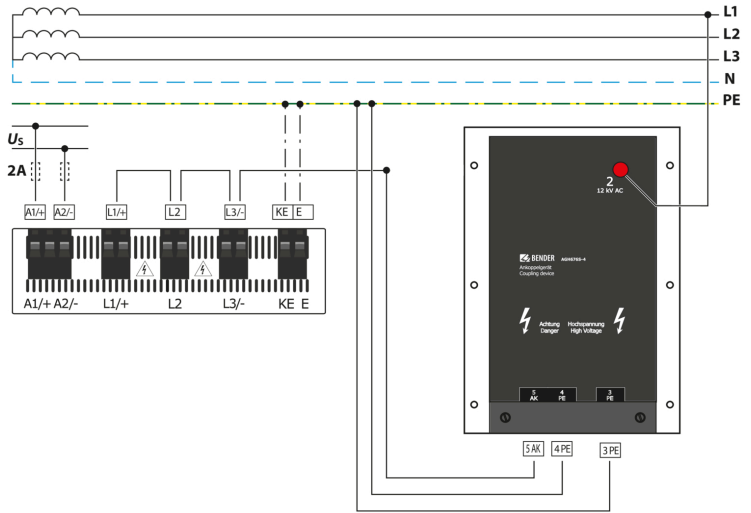

# 11 Alarm messages

## 11.1 General alarms

Alarm messages are activated as soon as the device has been switched on and can be signalled immediately.

Message	Description	Actions
Undervoltage	Operating outside the specified supply voltage range	<ul style="list-style-type: none"> <li>Check supply voltage.</li> </ul>
Overvoltage	Operating outside the specified supply voltage range	<ul style="list-style-type: none"> <li>Check supply voltage.</li> </ul>
Check L1-L2-L3 for correct connection! [LEDs <b>ALARM 1</b> , <b>ALARM 2</b> flash alternately]	No low-resistance connection between the line conductors	<ul style="list-style-type: none"> <li>Check the wiring of terminals <b>L1+</b>, <b>L2</b> and <b>L3/-</b> to the IT system.</li> <li>Press the button <b>TEST</b>.</li> <li>Check nominal system voltage.</li> <li>Check the back-up fuses.</li> <li>Check set system type.</li> </ul>
Check E-KE connections for interruptions! [LEDs <b>ALARM 1</b> , <b>ALARM 2</b> flash in common mode]	No low-resistance connection between terminals <b>E</b> and <b>KE</b> to earth (PE)	<ul style="list-style-type: none"> <li>Check the wiring of terminals <b>E</b> and <b>KE</b> to earth (PE).</li> <li>Press the button <b>TEST</b>.</li> </ul>
Profile not suitable for the application!	Wrong profile selected for this application	<ul style="list-style-type: none"> <li>Check measured system capacitance or mains frequency in the menu <b>Info</b>.</li> <li>Select another profile taking the characteristics into consideration.</li> </ul>
Loads on X1 too high!	Sum of the external loads on <b>X1</b> is too high.	<ul style="list-style-type: none"> <li>Check load at <b>X1+</b>, <b>X1.Q1</b> and <b>X1.Q2</b>.</li> <li>Check ambient temperature.</li> </ul>
Check date and time!	Date and time have not yet been set.	<ul style="list-style-type: none"> <li>Set local date and time (in case of voltage failure buffer for three days).</li> </ul>
No DHCP server found!	Connection problem at the Ethernet interface	<ul style="list-style-type: none"> <li>Check cable connection at the Ethernet interface.</li> <li>Check the DHCP server's availability.</li> <li>Check the DHCP's interface configuration in the device.</li> </ul>
Device error x.xx [LED <b>SERVICE</b> is lit]	Internal device error	<ul style="list-style-type: none"> <li>Press the button <b>TEST</b>.</li> <li>Switch the supply voltage off and on.</li> <li>Contact Bender Service.</li> </ul>
DC offset voltage	There is a DC offset voltage in the system.	<ul style="list-style-type: none"> <li>Check insulation fault and eliminate fault of DC components.</li> </ul>
Synchronising ...	The device synchronises over a longer period of time. (longer than five minutes)	<ul style="list-style-type: none"> <li>Restart.</li> </ul>
BCOM connection interrupted!	No connection to devices can be made within the BCOM system due to a) an interrupted bus conductor, b) incorrect Ethernet settings, c) incorrect grouping.	<ol style="list-style-type: none"> <li>Connect bus conductor correctly.</li> <li>Correct Ethernet settings.</li> <li>Restore configuration using the BCOM Group Manager.</li> </ol>
Service mode active! [LED <b>SERVICE</b> is lit]	The device is in maintenance condition.	<ul style="list-style-type: none"> <li>Contact Bender Service.</li> </ul>

## 11.2 Measured value alarms

Alarm messages are activated as soon as the device has been switched on and can be signalled immediately.

Message	Description	Actions
Insulation fault prewarning [LED <b>ALARM 1</b> is lit]	An insulation fault exists. The insulation resistance falls below the response value $R_{an1}$ .	<ul style="list-style-type: none"><li>• Watch insulation resistance in the monitored system.</li><li>• Reset fault message by pressing the <b>RESET</b> button.</li></ul>
Insulation fault main alarm [LED <b>ALARM 2</b> is lit]	An insulation fault exists. The insulation resistance falls below the response value $R_{an2}$ .	<ul style="list-style-type: none"><li>• Eliminate insulation fault in the system being monitored.</li><li>• Reset fault message by pressing the <b>RESET</b> button.</li></ul>
DC offset voltage	There is a DC offset voltage in the system.	<ul style="list-style-type: none"><li>• Check insulation fault and eliminate fault of DC components.</li></ul>

## 12 Technical data

### 12.1 Device profiles

**i** When switching a profile, the value of  $R_{min}$  is reset. Switching a profile may result in longer measuring times.

Adjustments to different applications can be made by selecting a device profile. The following device profiles are available:

#### Power circuits

Main circuits without dynamic frequency changes. The universal profile is suitable for all systems with primarily constant system frequencies and extraneous DC voltages. When using inverters and dynamic frequency control, select **Inverter > 10 Hz** or **Inverter < 10 Hz**.

$U_n$	$F_n$	$C_e$	$U_m$	Measuring range	Response values
AC 0...690 V DC 0...1000 V	15...460 Hz	0...150 $\mu$ F	$\pm$ 50 V	0.1 k $\Omega$ ...20 M $\Omega$	1 k $\Omega$ ... 10 M $\Omega$

**Response time  $t_{an}$  "Power circuits" profile as a function of response value  $R_{an}$  and system leakage capacitance  $C_e$  acc. to IEC 61557-8 ( $U_n = 690$  V,  $f = 50$  Hz) measuring range < 10 M $\Omega$**

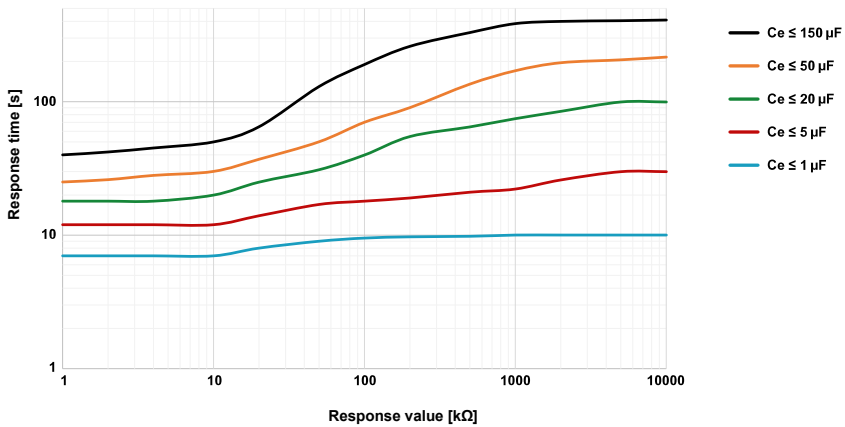

## Control circuits

This profile is used to reduce the measurement voltage  $U_m$  in control systems with lower nominal voltages in order to reduce the impact by the ISOMETER® on sensitive switching elements.

$U_n$	$F_n$	$C_e$	$U_m$	Measuring range	Response values
AC 0...230 V DC 0...230 V	15...460 Hz	0...150 $\mu$ F	$\pm 10$ V	0.1 k $\Omega$ ... 20 M $\Omega$	1 k $\Omega$ ... 10 M $\Omega$

**Response time  $t_{an}$  "Control circuits" profile as a function of response value  $R_{an}$  and system leakage capacitance  $C_e$  acc. to IEC 61557-8 ( $U_n = 690$  V,  $f = 50$  Hz) measuring range  $< 10$  M $\Omega$**

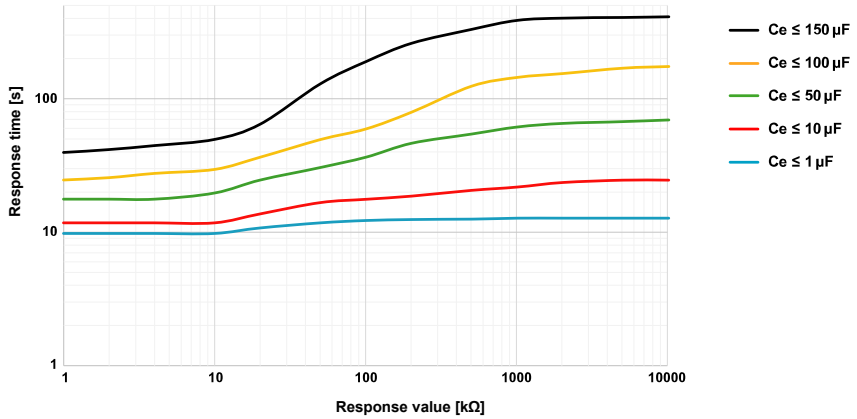

### Generator

This profile allows the realisation of a very fast measuring time, e.g. as required for generator monitoring. Furthermore, this profile can be used to support fast fault location in an IT system. The generator profile is suitable for AC systems containing DC components.

$U_n$	$F_n$	$C_e$	$U_m$	Measuring range	Response values
AC 0...690 V	50...60 Hz	0...5 $\mu$ F	$\pm$ 50 V	0.1 k $\Omega$ ... 20 M $\Omega$	1 k $\Omega$ ... 10 M $\Omega$

**Response time  $t_{an}$  "Generator" profile as a function of response value  $R_{an}$  and system leakage capacitance  $C_e$  acc. to IEC 61557-8 ( $U_n = 690$  V,  $f = 50$  Hz) measuring range < 10 M $\Omega$**

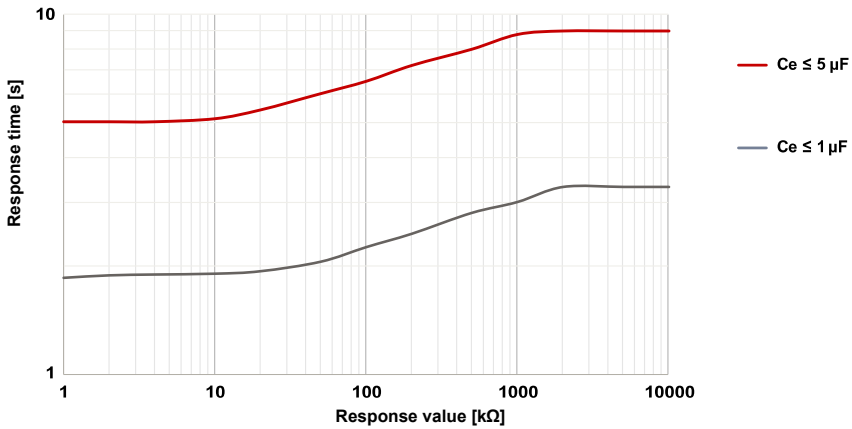



## High capacitance

For systems with high system leakage capacitances, e.g. ship applications, the impact of system leakage capacitances on the measuring result can be significantly reduced by selecting this profile.

$U_n$	$F_n$	$C_e$	$U_m$	Measuring range	Response values
AC 0...690 V DC 0...1000 V	15...460 Hz	0...1000 $\mu\text{F}$	$\pm 50$ V	0.1 k $\Omega$ ... 20 M $\Omega$	1 k $\Omega$ ... 10 M $\Omega$

**Response time  $t_{an}$  "High capacitance" profile as a function of response value  $R_{an}$  and system leakage capacitance  $C_e$  acc. to IEC 61557-8 ( $U_n = 690$  V,  $f = 50$  Hz) measuring range  $< 10$  M $\Omega$**

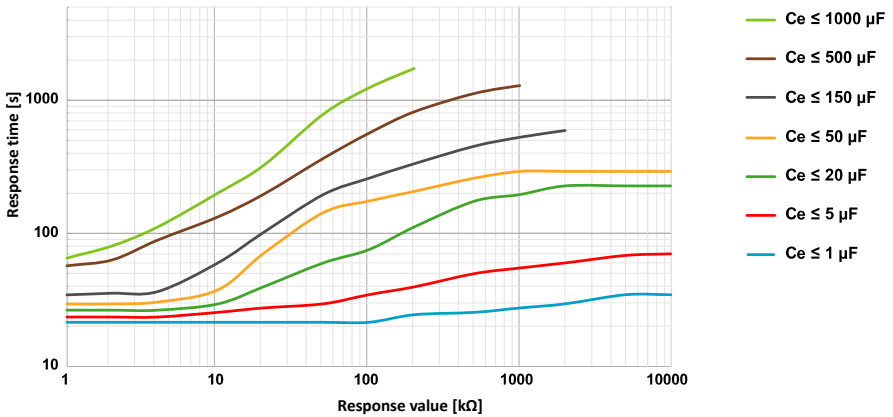

### Inverter > 10 Hz

This profile is used for systems with dynamic frequency control by inverters in the range 10...460 Hz in order to optimise the measurement with respect to the measuring time and quality.

$U_n$	$F_n$	$C_e$	$U_m$	Measuring range	Response values
AC 0...690 V DC 0...1000 V	10...460 Hz	0...20 $\mu$ F	$\pm$ 50 V	0.1 k $\Omega$ ... 20 M $\Omega$	1 k $\Omega$ ... 10 M $\Omega$

**Response time  $t_{an}$  "Inverter > 10 Hz" profile as a function of response value  $R_{an}$  and system leakage capacitance  $C_e$  acc. to IEC 61557-8 ( $U_n = 690$  V,  $f = 50$  Hz) measuring range < 10 M $\Omega$**

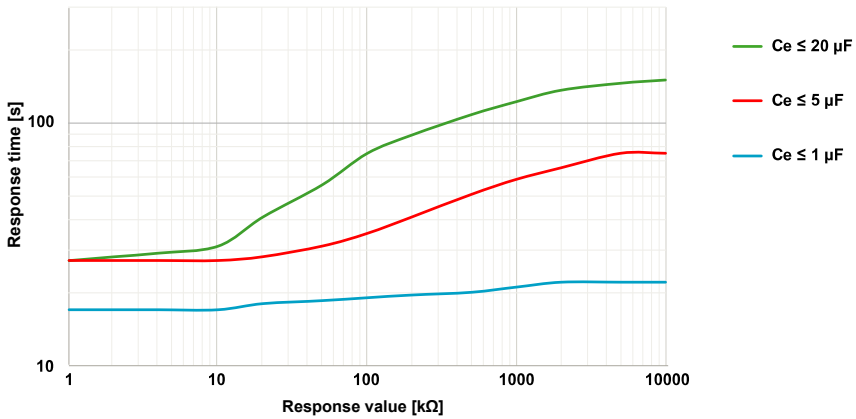

### Inverter < 10 Hz

For systems involving extremely low-frequency controls in the range of up to 0.1...460 Hz and very slowly and continuously changing extraneous DC voltages due to dynamic load conditions in an IT system, continuous insulation monitoring can be optimised using this profile.

$U_n$	$F_n$	$C_e$	$U_m$	Measuring range	Response values
AC 0...690 V DC 0...1000 V	0.1...460 Hz	0...20 $\mu$ F	$\pm 50$ V	0.1 k $\Omega$ ... 20 M $\Omega$	1 k $\Omega$ ... 10 M $\Omega$

**Response time  $t_{an}$  "Inverter < 10 Hz" profile as a function of response value  $R_{an}$  and system leakage capacitance  $C_e$  acc. to IEC 61557-8 ( $U_n = 230$  V,  $f = 50$  Hz) measuring range < 10 M $\Omega$**

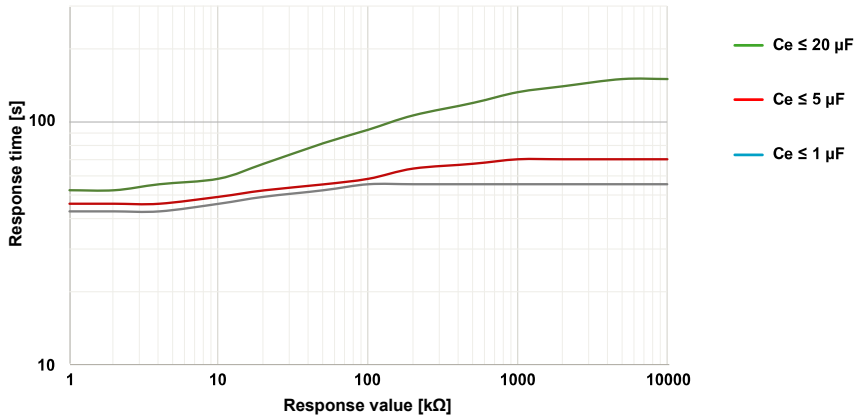

For very low-frequency systems, the nominal system voltage is reduced in accordance with the specifications in "Tabular data", page 78.

### Customer-specific

Enables Bender Service to make customised measurement settings to make customised measurement settings. If no settings have been made by Bender Service, the profile has the same parameters as the **Power circuits** profile.

## 12.2 Operating uncertainty

Operating uncertainty [%] as a function of response value  $R_{an}$  and system leakage capacitance  $C_e$  acc. to IEC 61557-8 ( $U_n = 690\text{ V}$ ,  $f = 50\text{ Hz}$ ); measuring range  $< 10\text{ M}\Omega$

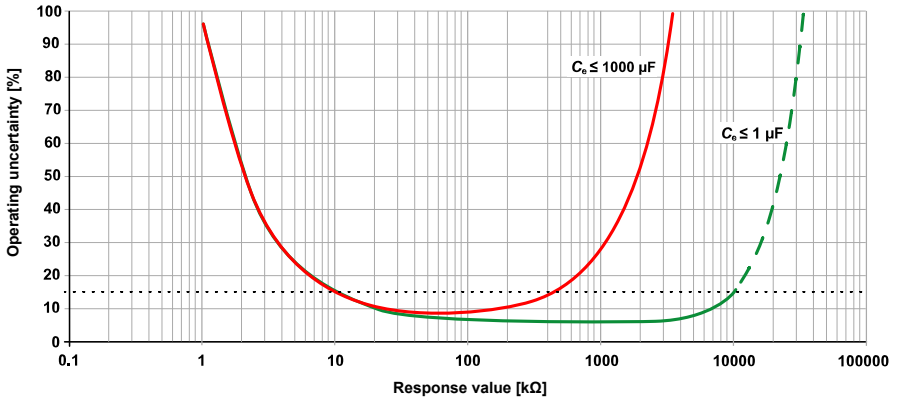

## 12.3 Factory settings

<b>System</b>	
System type	3AC
System profile	Power circuits
Coupling (Coupling device)	none
Coupling monitoring	on
Start-up delay $t_{\text{start}}$	0 ms

<b>Response values/alarms</b>	
Response value $R_{\text{an1}}$ (ALARM 1)	40 k $\Omega$
Response value $R_{\text{an2}}$ (ALARM 2)	10 k $\Omega$
DC alarm	off
DC offset voltage for DC alarm	65 V
Fault memory	off

<b>Digital inputs</b>	<b>1</b>	<b>2</b>	<b>3</b>
Mode (operating mode)	Active high	Active low	Active high
Function	TEST	RESET	Deactivate device

<b>Digital outputs</b>	<b>1</b>	<b>2</b>
Function 1	off	off
Function 2	off	off
Function 3	off	off

<b>Switching elements (relays)</b>	<b>1</b>	<b>2</b>
Test	on	on
Relay mode	N/C operation	N/C operation
Function 1	Ins. alarm 1	Ins. alarm 2
Function 2	Connection fault	Device error
Function 3	off	Connection fault

<b>Interfaces</b>	
DHCP	off
IP address	192.168.0.5
Subnet mask	255.255.255.0
BCOM name	system-1-0'
Device address BS bus	1
isoData	Mode 1
<b>Modbus RTU</b>	via RS485

Address	100
Baud rate	19.2 kBd
Parity	even
Stop bits	1

\* The BCOM name is not changed when the factory settings are restored.

## 12.4 Tabular data

### Insulation coordination acc. to IEC 60664-1/-3

Rated voltage	1000 V
Overvoltage category	III

#### Definitions

Measuring circuit (IC1)	L1/+, L2, L3/-
Supply circuit (IC2)	A1, A2
Output circuit 1 (IC3)	11, 12, 14
Output circuit 2 (IC4)	21, 22, 24
Control circuit (IC5)	(E, KE), X1, ETH, X3, X4

#### Rated impulse voltage

IC1/(IC2-5)	8 kV
IC2/(IC3-5)	4 kV
IC3/(IC4-5)	4 kV
IC4/IC5	4 kV

#### Rated insulation voltage

IC1/(IC2-5)	1000 V
IC2/(IC3-5)	250 V
IC3/(IC4-5)	250 V
IC4/IC5	250 V
Pollution degree outside ( $U_n < 690$ V)	3
Pollution degree outside ( $690$ V $< U_n < 1000$ V)	2

#### Protective separation (reinforced insulation) between

IC1/(IC2-5)	Overvoltage category III, 1000 V
IC2/(IC3-5)	Overvoltage category III, 300 V
IC3/(IC4-5)	Overvoltage category III, 300 V
IC4/IC5	Overvoltage category III, 300 V

**Voltage test (routine test) according to IEC 61010-1**

IC2/(IC3-5)	AC 2.2 kV
IC3/(IC4-5)	AC 2.2 kV
IC4/IC5	AC 2.2 kV

**Supply voltage**
**Supply via A1/+ , A2/-**

Supply voltage range $U_s$	AC/DC 24...240 V
Tolerance of $U_s$	-30...+15 %
Maximum permissible input current of $U_s$	650 mA
Frequency range of $U_s$	DC, 50...400 Hz *
Tolerance of $U_s$ frequency range	-5...+15 %
Power consumption, typical at DC	≤ 12 W
Power consumption, typical at 50/60 Hz	≤ 12 W/21 VA
Power consumption, typical at 400 Hz	≤ 12 W/45 VA

\* At frequencies > 200 Hz, the connection of X1 and remote must be shockproof. Only permanently installed devices which at least have overvoltage category II (300 V) may be connected.

**Supply via X1**

Supply voltage $U_s$	DC 24 V
Tolerance of $U_s$	-20...+25 %

**IT system being monitored**

Nominal system voltage range $U_n$	AC 0...690 V DC 0...1000 V
Nominal system voltage range $U_n$ for UL applications	AC/DC 0...600 V
Tolerance of $U_n$	AC/DC +15 %
Frequency range of $U_n$	DC 0.1...460 Hz
Max. alternating voltage $U^-$ (for $f_n < 4$ Hz)	$U^-_{\max} = 50 \text{ V} \times (1 + f_n^2)$

**Response values**

Response value $R_{an1}$ (ALARM 1)	1 kΩ ... 10 MΩ
Response value $R_{an2}$ (ALARM 2)	1 kΩ ... 10 MΩ
Relative uncertainty (acc. to IEC 61557-8)	profile-dependent, ±15 %, min. ±1 kΩ
Hysteresis	25 %, min. 1 kΩ

### Time response

Response time $t_{an}$ at $R_f = 0.5 \times R_{an}$ (10 k $\Omega$ ) and $C_e$ (1 $\mu$ F) acc. to IEC 61557-8	profile-dependent, typ. 4 s
Response time DC alarm at $C_e = 1 \mu$ F	profile-dependent, typ. 2 s
Start-up delay $t_{start}$	0 s ... 10 min

### Measuring circuit

Measuring voltage $U_m$	profile-dependent, $\pm 10$ V, $\pm 50$ V (see device profiles)
Measuring current $I_m$	$\leq 403 \mu$ A
Internal resistance $R_f, Z_i$	$\geq 124$ k $\Omega$
Permissible extraneous DC voltage $U_{fg}$	$\leq 1200$ V
Permissible system leakage capacitance $C_e$	profile-dependent, 0...1000 $\mu$ F

### Measuring ranges

Measuring range $f_n$	0.1...460 Hz
Tolerance, measurement of $f_n$	$\pm 1$ % $\pm 0.1$ Hz
Voltage range, measurement of $f_n$	AC 25...690 V
Measuring range $U_n$	AC 25...690 V DC 0...1000 V
Voltage range, measurement of $U_n$	AC/DC $> 10$ V
Tolerance, measurement of $U_n$	$\pm 5$ % $\pm 5$ V
Measuring range $C_e$	0...1000 $\mu$ F
Tolerance, measurement of $C_e$	$\pm 10$ % $\pm 10 \mu$ F
Frequency range, measurement of $C_e$	DC, 30...460 Hz
Insulation resistance, measurement of $C_e$ depending on the profile and coupling mode	typ. $> 10$ k $\Omega$

### Display

Display	Graphic display 127 x 127 pixel, 40 x 40 mm *
Display range, measured value	0.1 k $\Omega$ ... 20 M $\Omega$
Operating uncertainty (acc. to IEC 61557-8)	$\pm 15$ %, min. 1 k $\Omega$

\* Indication is limited outside the temperature range  $-25...+55$   $^{\circ}$ C.



## LEDs

ON (operation LED)	green
SERVICE	yellow
ALARM 1	yellow
ALARM 2	yellow

## Inputs/outputs (X1)

Cable length X1 (unshielded cable)	≤ 10 m
Cable length X1 (shielded cable, shield connected to PE on one side) recommended: J-Y(St)Y min. 2x0.8	≤ 100 m
Max output current for supply via X1+/X1GND per output	1 A
Max output current for supply via A1/A2 in total on X1	200 mA
Max output current for supply via A1/A2 in total on X1 between 16.8 V and 40 V	$I_{L_{\max X1}} = 10 \text{ mA} + 7 \text{ mA} / V \times U_s^*$

- \*  $U_s$  is the supply voltage of the ISOMETER®.  
Negative values for  $I_{L_{\max X1}}$  are not permissible.

## Digital inputs (I1, I2, I3)

Number	3
Operating mode, adjustable	active high, active low
Functions	off, test, reset, deactivate device, start initial measurement
Voltage	Low DC -3...5 V, High DC 11...32 V
Voltage tolerance	±10 %

## Digital outputs (Q1, Q2)

Number	2
Operating mode, adjustable	active, passive
Functions	off, Ins. Alarm 1, Ins. Alarm 2, connection fault, DC- alarm *, DC+ Alarm *, symmetrical alarm, device error, common alarm, measurement complete, device inactive, DC offset alarm
Voltage	passive DC 0...32 V, active DC 0 / 19.2...32 V

- \* Only for  $U_n \geq 50 \text{ V}$

## Analogue output (M+)

Number	1
Operating mode, adjustable	linear, midscale point 28 kΩ/120 kΩ
Functions	insulation value, DC offset
Current (load)	0...20 mA (< 600 Ω) 4...20 mA (< 600 Ω) 0...400 μA (< 4 kΩ)

### Analogue output (M+)

Voltage (load)	0...10 V (>1 kΩ) 2...10 V (>1 kΩ)
Tolerance related to the current/voltage final value %	±20 %

### Interfaces

#### Field bus

Interface/protocol	web server/Modbus TCP/BCOM
Data rate	10/100 Mbit/s, autodetect
Max. number of Modbus requests	< 100/s
Cable	min. CAT 6
Cable length	≤ 100 m
Connection	RJ45
IP address	DHCP/manually: 192.168.0.5
Net mask	255.255.255.0
BCOM address	system-1-0
Function	Communication interface

#### Sensor bus

Interface / protocol	RS-485 / isoData, BS bus, Modbus RTU
Data rate Mode 1	9.6 kBd
Cable: twisted pairs, shield connected to PE on one side	recommended: J-Y(St)Y min. 2×0.8
Cable length (depending on the baud rate)	≤ 1200 m
Connection	terminals X1A, X1B
Terminating resistor	120 Ω, can be connected internally
Device address	1...90

### Switching elements

Switching elements	2 changeover contacts
Operating mode	n/c / n/o
Contacts (11-12-14 / 21-22-24)	off, Ins. Alarm 1, Ins. Alarm 2, connection fault, DC- alarm*, DC+ alarm*, symmetrical alarm, device error, common alarm, measurement complete, device inactive, DC offset alarm
Electrical endurance at rated operating conditions	10,000 operating cycles

\* Only for  $U_n \geq 50$  V

**Contact data acc. to IEC 60947-5-1**

Utilisation category	AC-13 / AC-14 / DC-12 / DC-12 / DC-12 / DC-12
Rated operational voltage	230 V / 230 V / 24 V / 48 V / 110 V / 220 V
Rated operational current	5 A / 3 A / 1 A / 1 A / 0.2 A / 0.1 A
Rated insulation voltage at $\leq 2000$ m AMSL	250 V
Rated insulation voltage at $\leq 3000$ m AMSL	160 V
Minimum contact rating	1 mA at AC/DC $\geq 10$ V

**Environment & EMC**

EMC	IEC 61326-2-4
Operating temperature	-25...+55 °C
Transport	-40...+85 °C
Long-term storage	-40...+70 °C

**Classification of climatic conditions acc. to IEC 60721** (with respect to temperature and rel. humidity)

Stationary use (IEC 60721-3-3)	3K22
Transport (IEC 60721-3-2)	2K11
Long-term storage (IEC 60721-3-1)	1K22

**Classification of mechanical conditions acc. to IEC 60721**

Stationary use (IEC 60721-3-3)	3M11
Transport (IEC 60721-3-2)	2M4
Long-term storage (IEC 60721-3-1)	1M12
Area of application	$\leq 3000$ m AMSL

**Connection**
**Screw-type terminals**

Nominal current	$\leq 10$ A
Tightening torque	0.5...0.6 Nm (5...7 lb-in)
Conductor sizes	AWG 24-12
Stripping length	7 mm
Wire cross-section	
rigid/flexible	0.2...2.5 mm <sup>2</sup>
flexible with ferrule with/without plastic sleeve	0.25...2.5 mm <sup>2</sup>
Multiple conductor, rigid	0.2...1 mm <sup>2</sup>
Multiple conductor, flexible	0.2...1.5 mm <sup>2</sup>
Multiple conductor, flexible with ferrule without plastic sleeve	0.25...1 mm <sup>2</sup>
Multiple conductor, flexible with TWIN ferrule with plastic sleeve	0.5...1.5 mm <sup>2</sup>

**Push-wire terminals**

Nominal current	≤ 10 A
Conductor sizes	AWG 24-12
Stripping length	10 mm
Wire cross-section	
rigid/flexible	0.2...2.5 mm <sup>2</sup>
flexible with ferrule with/without plastic sleeve	0.25...2.5 mm <sup>2</sup>
Multiple conductor, flexible with TWIN ferrule with plastic sleeve	0.5...1.5 mm <sup>2</sup>

**Push-wire terminals X1**

Nominal current	≤ 8 A
Conductor sizes	AWG 24-16
Stripping length	10 mm
Wire cross-section	
rigid/flexible	0.2...1.5 mm <sup>2</sup>
flexible with ferrule with/without plastic sleeve	0.25...1.5 mm <sup>2</sup>
flexible with ferrule with plastic sleeve	0.25...0.75 mm <sup>2</sup>

**Other**

Operating mode	continuous operation
Mounting position	display-oriented *
Degree of protection, internal components	IP40
Degree of protection, terminals	IP20
DIN rail mounting acc. to	IEC 60715
Screw mounting	3 x M4 with mounting clip
Enclosure material	polycarbonate
Flammability class (UL 94)	V-0
ANSI Code	64
Dimensions (W x H x D)	108 x 93 x 110 mm
Weight	< 390 g

- \* For best ventilation, align cooling slots vertically (0°).  
 At an alignment of 45° the max. operating temperature is reduced by 10 °C.  
 At an alignment fo 90° the max. operating temperature is reduced by 20 °C.

### Option “W”, data different from the standard version

Devices with the suffix **W** feature increased shock and vibration resistance. The electronics is covered with a special varnish to provide increased protection against mechanical stress and moisture.

Rated operational current for switching elements

max. 3 A (for UL applications)

#### Ambient temperatures

Operating temperature	−40...+70 °C
Operating temperature for UL applications	−40...+65 °C
Transport	−40...+85 °C
Long-term storage	−40...+70 °C

#### Classification of climatic conditions acc. to IEC 60721

Stationary use (IEC 60721-3-3)	3K23
--------------------------------	------

#### Classification of mechanical conditions acc. to IEC 60721

Stationary use (IEC 60721-3-3)	3M12
--------------------------------	------

**i** Combination of ISOMETER® sensor variant with an FP200W: The requirements of option **W** will only be fulfilled when the ISOMETER® sensor variant is mounted on a DIN rail and connected to the FP200W via the patch cable. Refer also to the quick-start guide FP200 (Document number D00169).

## 12.5 Standards and certifications

The ISOMETER® has been developed in compliance with the following standards:

- DIN EN 61557-8 (VDE 0413-8): 2015-12
- IEC 61557-8: 2014-12
- IEC 61557-8: 2014/COR1:2016
- DIN EN 61557-8 Cor 1 (VDE 0413-8 Cor 1): 2016-12

Subject to change! The specified standards take into account the edition valid until 02.09.2024 unless otherwise indicated.



## 12.6 Ordering details

### Device

Type	Supply voltage $U_s$	Article number
iso685-D	AC 24...240 V; 50...400 Hz; DC 24...240 V	B91067010
iso685W-D*	AC 24...240 V; 50...400 Hz; DC 24...240 V	B91067010W
iso685-S + FP200	AC 24...240 V; 50...400 Hz; DC 24...240 V	B91067210
iso685W-S + FP200W*	AC 24...240 V; 50...400 Hz; DC 24...240 V	B91067210W

\* Option **W**: Increased shock and vibration resistance 3K23; 3M12; Bezeichnung −40...+70 °C

## Accessories

Description	Article number
iso685 Mechanical accessories comprising terminal cover, 2 mounting clips *	B91067903
iso685 connector kit for screw-type terminals *	B91067901
iso685 connector kit for push-wire terminals	B91067902

\* included in the scope of delivery

## Suitable system components

Type	Description	Article number
7204-1421	Suitable measuring instruments mid scale: 28 k $\Omega$ ; 120 k $\Omega$ Current values: 0...400 $\mu$ A; 0...20 mA	B986763
9604-1421		B986764
9620-1421		B986841
FP200	Display for front panel mounting	B91067904
FP200W*	Display for front panel mounting	B91067904W
iso685-S	ISOMETER® sensor variant * AC 24...240 V; 50...400 Hz; DC 24...240 V	B91067110
iso685W-S	ISOMETER® sensor variant * AC 24...240 V; 50...400 Hz; DC 24...240 V	B91067110W

\* Only available with separate FP200(W) panel

## Coupling devices

Type	Nominal voltage $U_n$	Article number
AGH150W-4	3(N)AC 0...1150 V; DC 0...1760 V	B98018006
AGH520S	AC/3(N)AC 0...7200 V;	B913055
AGH204S-4	AC 0...1650 V; with rectifier: AC 0...1300 V	B914013
AGH676S-4	AC 12 kV	B913055

## 12.7 Document revision history

Date	Document version	Valid from software version	State/Changes
02/2021	10	D0438 V1.27 D0437 V1.26	Editorial revision Inserted – Menu entry "Behaviour when inactive" – Contact details of the relays – UKCA certificate – Document revision history
10/2021	11		Editorial revision Technical data as with iso685-x

Date	Document version	Valid from software version	State/Changes
02/2024	12		Changes <ul style="list-style-type: none"> <li>– “Caution: This equipment is not intended for use in residential environments and may not provide adequate protection to radio reception in such environments.”, page 9 according to VDE; removed from tabular data</li> <li>– Figure “• <b>Linear</b>”, page 46: value changed from 100 Ω to 10 kΩ</li> </ul> Editorial revision with transfer to SMC
08/2024	13	D0438 V1.29 D0437 V1.27	<ul style="list-style-type: none"> <li>– EDS menu area removed from “Parameter changes”, page 56</li> <li>– Diagrams for response times in “Device profiles”, page 70</li> <li>– Added: “Operating uncertainty”, page 76</li> <li>– Added: Parameter 200 kΩ and 400 kΩ in “Menu item: Midscale”, page 46</li> </ul>

## 13 Glossary

<b>BS bus</b>	The Bender sensor bus is an interface which enables Bender devices to communicate with each other (RS-485 interface).
<b>DHCP</b>	Dynamic Host Configuration Protocol. It is used to assign the network configuration to Clients via a server.
<b>Modbus TCP</b>	Modbus is an internationally widely-used protocol for data transmission. The data are transmitted via the TCP protocol.
<b>Modbus RTU</b>	The data are transmitted via the RS-485 protocol.
<b>web server</b>	A web server represents the device functions graphically. The web server can be used for reading out measured values and for parameter setting.





**Bender GmbH & Co. KG**

Londorfer Straße 65  
35305 Grünberg  
Germany

Tel.: +49 6401 807-0  
info@bender.de  
www.bender.de

Alle Rechte vorbehalten.  
Nachdruck und Vervielfältigung nur mit  
Genehmigung des Herausgebers.

All rights reserved.  
Reprinting and duplicating only with  
permission of the publisher.



© Bender GmbH & Co. KG, Germany  
Subject to change! The specified  
standards take into account the edition  
valid until 08.2024 unless otherwise  
indicated.