



isoMED427P-CX



AC/DC

MED

绝缘监视仪

ZH

使用目的

ISOMETER® isoMED427P-CX 监视医疗 IT 系统中的绝缘电阻 R_F ，其范围为 AC 70...264 V。此外，还监视 IT 系统变压器的负载电流和温度。一旦检测到绝缘故障，内置定位电流发射器能够及时定位到绝缘故障。

报警和测量值通过 BMS 接口传送给其他总线设备。

对于报警和状态显示，建议使用特殊的报警显示和测试单元。对于绝缘故障定位，推荐使用 EDS 系列设备。推荐使用 page 11 上列表上的设备组合。

isoMED427P-CX 不需要独立的电源。最大允许系统泄漏电容 C_e 是 5 μ F。

通用安全信息

除了这份技术参数外，设备的文件还包含一张题为“本德产品的重要安全说明”的表格。

设备特殊安全信息



提醒

由于安装不专业而造成财产损坏的风险!

如果有超过一台绝缘监视仪连接到带电系统中，那系统可到会损坏。如果连接数个设备，那设备不能实现功能并且不会发出绝缘故障信号。确保在每个带电系统中，仅连接一台绝缘监视仪。



提醒

确保与 IT 系统断开!

当执行绝缘或电压测试时，在测试阶段设备必须与系统隔离。否则设备可能会损坏。

功能

在普通操作时，显示屏显示当前测量的绝缘电阻值。向上和向下按钮用于选择显示当前测量的负载电流的百分比。如果绝缘电阻下降且低于响应值时，LED AL1 会发出绝缘故障信号。当负载电流过高时，LED AL2 会点亮；当超出被监视的 IT 系统的变压器温度时，报警继电器 K1 会发出全部报警类型的信号。此外，通过端子 A 提供总线信号，端子 B 用于绝缘故障定位和报警显示和指示单元。

一旦检测到绝缘故障，内置的故障定位电流发射器立刻进行绝缘故障定位，前提是在菜单中已经打开 EDS 功能（工厂设置 = off）。在 2 秒的交替时间内，注入正、负定位电流脉冲到被监视的 IT 系统中，其间有 4 秒的无脉冲暂停时间。

Insulation monitoring device

EN

Intended use

The ISOMETER® isoMED427P monitors the insulation resistance R_F in medical IT systems of AC 70...264 V. In addition, the IT system transformer's load current and temperature are monitored. Once an insulation fault is detected, the internal locating current injector allows insulation faults to be localised.

Alarms and measured values are made available to other bus devices via the BMS interface.

For alarm and status indication the use of special alarm indicator and test combinations is recommended. For insulation fault localisation appropriate devices of the EDS series are recommended to be used. Recommended device combinations are listed in the table on page 11.

isoMED427P does not require separate supply voltage. The maximum permissible system leakage capacitance C_e is 5 μ F.

General safety information

In addition to this data sheet, the documentation of the device includes a sheet entitled "Important safety instructions for Bender products".

Device-specific safety information



CAUTION

Risk of property damage due to unprofessional installation!

If more than one insulation monitoring device is connected to a conductively connected system, the system can be damaged. If several devices are connected, the device does not function and does not signal insulation faults. Make sure that only one insulation monitoring device is connected in each conductively connected system.



CAUTION

Ensure disconnection from the IT system!

When insulation or voltage tests are to be carried out, the device shall be isolated from the system for the test period. Otherwise the device may be damaged.

Function

In normal operation, the display indicates the currently measured insulation resistance value. The Up and Down buttons are used to select the display indication of the currently measured load current in percentages. If the insulation resistance falls below the response value, LED AL1 will signal an insulation fault. LED AL2 lights when the load current is too high and when the temperature of the monitored IT system transformer is exceeded, alarm relay K1 signals all types of alarms. In addition, a bus signal is provided across the terminals A, B for insulation fault locators and alarm indicator and test combinations.

Once an insulation fault is detected, the internal locating current injector is activated for insulation fault location, provided that the EDS function has been switched on in the menu before (factory setting = off). For a duration of 2 seconds alternately a positive and negative locating current pulse is injected to the IT system being monitored with a no-pulse pause of 4 s in between.

isoMED427P-CX 只能作为 BMS 从属工作。这就是为什么报警指示器或者绝缘故障定位仪作为主机。BMS 地址 1 必须被分配为 BMS 主机。

自动自检

在连接到电源电压和之后的每个小时，设备会自动执行自检。在自检过程中，可以确定内部功能故障或连接故障将，并以错误代码的形式显示在显示屏上。在测试过程中，报警继电器不会切换。

手动自检

按下内置或外部测试按钮并且持续超过 2 秒，设备会执行自检。在测试过程中，可以确定内部功能故障或连接故障将，并以错误代码的形式显示在显示屏上。在测试过程中，报警继电器会动作。

当按下测试按钮“T”时，设备显示所有可用的元件。

功能性故障

如果发生故障，继电器 K1 (11, 12, 14) 和所有三个 LED 闪烁。故障代码出现在显示屏上。

E01 = PE 连接故障，在 E 和 KE 之前没有低电阻连接。

E03 = 测量电流互感器中断

E04 = 短路测量电流互感器

E05...Exx = 内部设备错误，联系本德尔服务中心

密码保护

如果已经启用密码保护 (on)，只有在输入正确密码的情况下才能设置 (0...999)。

出厂设置 FAC

在启动出厂设置之后，之前更改的所有设置都会重置为运输状态。

监视 IT 系统变压器

设备通过评估 PTC 的电阻值来监视温度。当达到 4 kΩ 的响应值时，激活报警显示超温，显示超过 > °C。不显示温度值。



提醒

为了避免变压器过载，负载电流监视需要与温度监视结合。
更详细的内容请参考接线图！

安装和连接



危险

电击造成致命伤害的危险！

接触系统的带电部件会产生电击的危险。在安装外壳和设备连接工作之前，请确保电源已断开，系统已断电。遵守现场工作的安装规则。

- isoMED427P-CX符合标准 IEC 60715 的 DIN 导轨安装或下面描述的螺丝安装。

The isoMED427P can only be operated as BMS slave. That is why the alarm indicator or the insulation fault locator operates as the Master. BMS address 1 must always be assigned to the BMS master.

Automatic self test

The device automatically carries out a self test after connecting to the supply voltage and later every hour. During the self test internal functional faults or connection faults will be determined and will appear in form of an error code on the display. The alarm relay is not switched over during this test.

Manual self test

After pressing the internal or the external test button for > 2 s, the device carries out a self test. During this test, internal functional faults, or connection faults will be determined and will appear in form of an error code on the display. The alarm relay will be switched during this test.

Whilst the test button "T" is pressed, all display elements available for this device are shown.

Functional faults

In case of a malfunction, the relay K1 (11, 12, 14) and all of the three LEDs flash. An error code appears on the display.

E01 = PE connection fault, no low-resistance connection between E and KE.

E03 = Measuring current transformer interruption

E04 = Short-circuit measuring current transformer

E05...Exx = Internal device error, contact the Bender service.

Password protection

If password protection has been activated (on), settings can only be made subject to the correct password being entered (0...999).

Factory setting FAC

After activating the factory setting, all settings previously changed are reset to delivery status.

Monitoring the IT system transformer

The device monitors the temperature by evaluating the resistance value of a PTC. When a response value of 4 kΩ is reached, an alarm will be activated indicating overtemperature, the display shows > °C. Temperature values will not be indicated.



CAUTION

In order to avoid transformer overload, load current monitoring should be combined with temperature monitoring.
For details refer to the wiring diagram!

Installation and connection



DANGER

Risk of fatal injury from electric shock!

Touching live parts of the system carries the risk of electric shock. Before fitting the enclosure and working on the device connections, make sure that the power supply has been disconnected and the system is dead. Observe the installation rules for live working.

- The isoMED427P is suitable for DIN rail mounting acc. to IEC 60715 or for screw mounting, as described below.

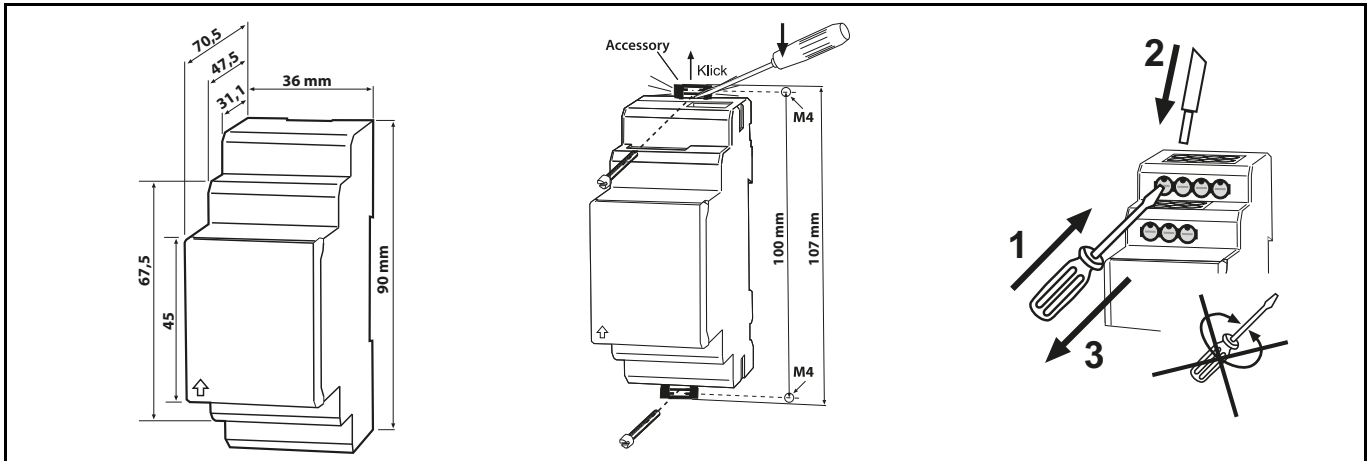

接线图

Wiring diagram

触电危险!
如果设备的端子 L1, L2 被连接到 IT 系统, 由于运行原因, 不能切断 E 和 KE 端子与保护接地线 (PE) 的连接。

危险

Risk of electric shock!
If the terminals L1, L2 of the device are connected to an IT system that is energised for operational reasons, the terminals E and KE must not be disconnected from the protective conductor (PE).

DANGER

按照接线图连接设备。到 KE 和 E 的接线必须分开连接!
BMS 总线必须在 2 个终端终止!

Connect the device according the wiring diagram.
The leads to KE and E have to be connected separately!
The BMS bus must be terminated at both ends!

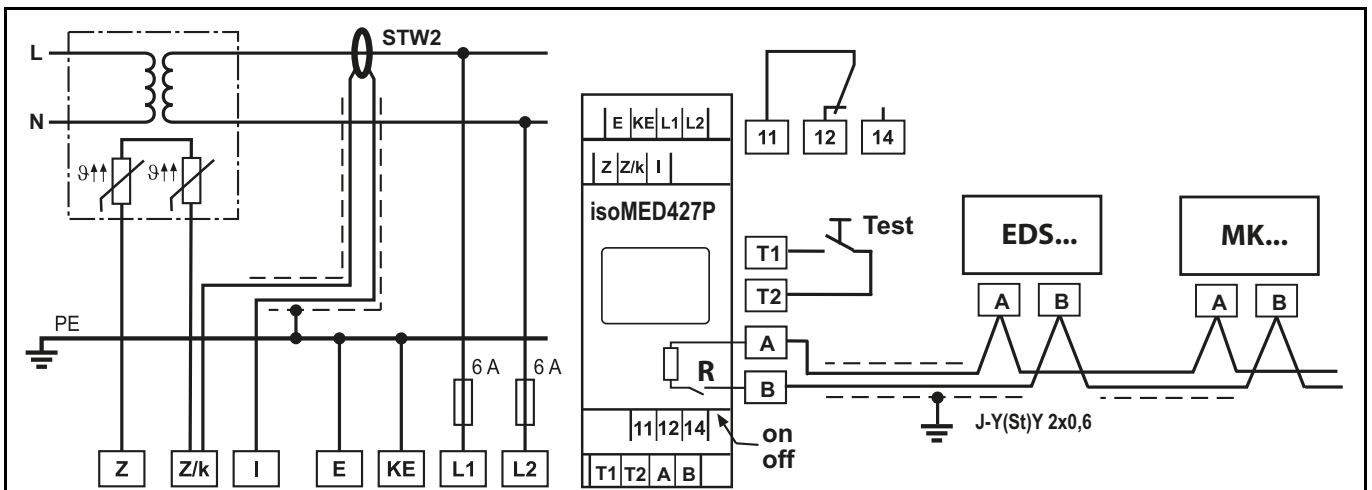

端子	连接
E, KE	E 和 KE 分别连接到 PE
L1, L2	连接到被监视的 IT 系统。 电源电压 (参考铭牌) 推荐 6 A 保险丝
Z, Z/k	连接到温度传感器 (PTC)
Z/k, I	连接到测量电流互感器 (STW2)
T1, T2	连接到外部测试按钮
A, B	RS-485 接口, 如果在总线的末端连接设备, 则用开关 R (on, off) 终止连接。
11, 12, 14	报警继电器 K1

Terminal	Connections
E, KE	Connect the leads E and KE separately to PE
L1, L2	Connection to the IT system being monitored. Supply voltage (see nameplate) 6 A fuse recommended
Z, Z/k	Connection to the temperature sensor (PTC)
Z/k, I	Connection to the measuring current transformer (STW2)
T1, T2	Connection for external test button
A, B	RS-485 interface, Terminate the connection with switch R (on, off) if the device is connected at the end of the bus.
11, 12, 14	Alarm relay K1

启动

在启动之前，请仔细检查 ISOMETER® 的连接。



在断开的系统上使用整整的接地故障执行功能测试，例如，通过一个合适的电阻。

Commissioning

Prior to commissioning, check proper connection of the ISOMETER®.



Perform a functional test on the disconnected system using a genuine earth fault, e.g. via a suitable resistance.

显示和操作元素

Display and operating elements

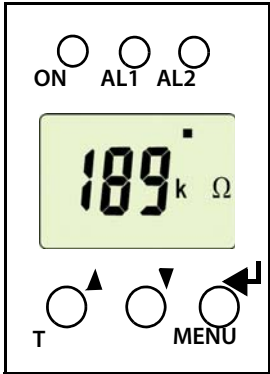
元件	功能	设备的正面 / Front of the device	Element	Function
ON	打开电源 LED，绿色		ON	Power On LED, green
AL1	LED 报警 1 亮起 (黄色)； 响应值 R_{an} 下降到极限值以下		AL1	LED Alarm 1 lights (yellow): Response value R_{an} has fallen below the limit
AL2	LED 报警 2 亮起 (黄色)； 响应值 % I 或 / 和 °C 超出		AL2	LED Alarm 2 lights (yellow): Response value % I or/and °C exceeded
■ 189 kΩ	用标准模式显示： 闪烁点 = 测量脉冲 绝缘值 $R_F = 189 \text{ k}\Omega$		Test ▲	Display in standard mode: Flashing point = measuring pulse Insulation resistance $R_F = 189 \text{ k}\Omega$
T ▲	测试按钮 „T“：启动自检 (2 s)； 向上按钮：菜单项 / 值		▼	Test button „T“: to start a self test (2 s); UP button: Menu items/values
▼	向下按钮：菜单项 / 值		MENU ←	DOWN button: Menu items/values
菜单 ←	启动菜单模式 (2 s)； ENTER 按钮： (< 1.5 s) 确认菜单项、子菜单项和值。 (2 s) 返回到下一级的菜单		MENU ←	To start the menu mode (2 s)； ENTER button: (< 1.5 s) To confirm menu item, submenu item and value. (2 s) To return to the next higher menu level

用标准模式显示

如果在此期间没有报警，ON LED 亮起并且当前测量值会出现在显示屏上。向上和向下按钮被用于切换绝缘电阻值和用百分比表示的当前测量负载电流。如果在更改显示后按下 Enter 按钮，则当前的显示保持不变。

Display in standard mode

If there is no alarm pending, the ON LED lights and the currently measured values are shown on the display. The Up and Down buttons are used to switch over between the indication of the insulation resistance value and the currently measured load current in percentages. If the Enter button is pressed after changing the display, the present display remains.

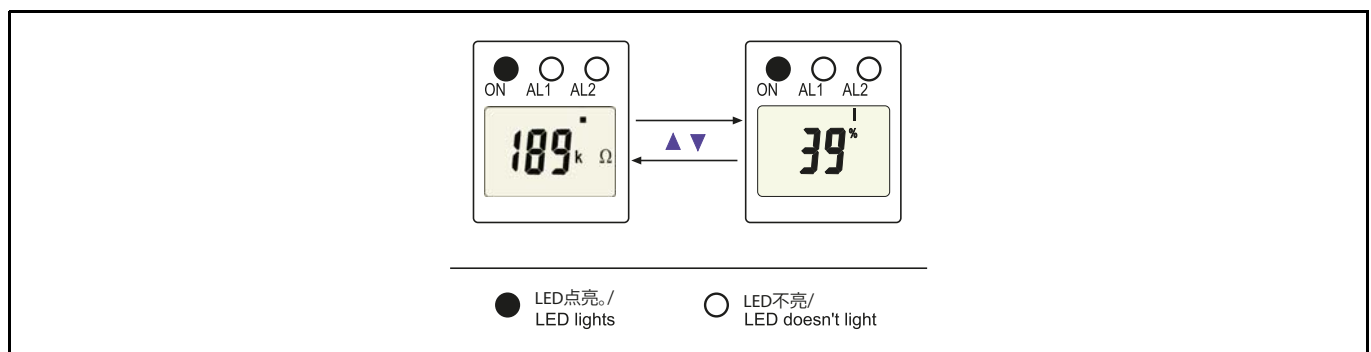

报警显示和 EDS 工作

显示举例:

Alarm indication and EDS activity

Examples of displays:

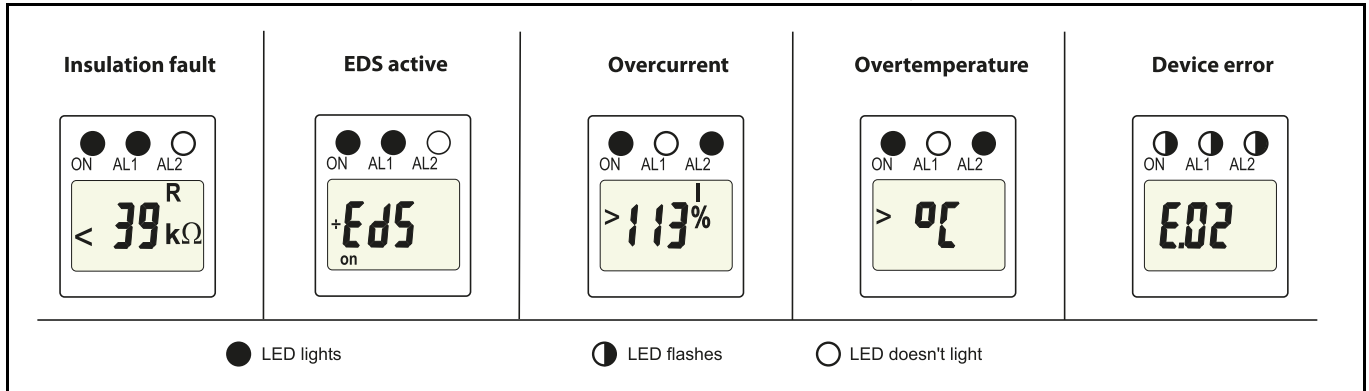

如果同时发生不同的报警，则显示指示以 3 秒间隔发生变化。

If different alarms occur simultaneously, the display indication changes at 3-second intervals.

出厂设置

响应值 R_{an} :	50 k Ω (< R)
响应值 I_{alarm} :	7 A (> I)
响应值 $^{\circ}C$:	4 k Ω (fixed value, for PTC measurement)
工作原理 K1:	N/C (n.c.) operation
BMS 地址:	3
自动绝缘故障定位:	off, 停用
密码:	0, 有缺陷的
CT 监视:	on, 工作
终端:	off, 停用 (120 Ω)

Factory setting

Response value R_{an} :	50 k Ω (< R)
Response value I_{alarm} :	7 A (> I)
Response value $^{\circ}C$:	4 k Ω (fixed value, for PTC measurement)
Operating principle K1:	N/C (n.c.) operation
BMS address:	3
Automatic insulation fault location:	off, deactivated
Password:	0, disabled
CT monitoring:	on, activated
Termination:	off, deactivated (120 Ω)

菜单概览

Menu overview

菜单, 子菜单	参数设置	菜单结构 / Menu structure	Menu, Sub-menu	Parameter setting
< R	查询和设置绝缘监视响应值		< R	Querying and setting the insulation monitoring response value
> I	查询和设置负载电流监视响应值 (A)		> I	Querying and setting the load current monitoring response value (A)
K1	为 K1 选择常开或常闭操作		K1	Select N/O or N/C operation for K1
Adr	设置 BMS 地址		Adr	Setting the BMS address
EdS	切换自动故障定位打开或关闭		Eds	Switch automatic fault location on or off
Sub	访问子菜单并从子菜单返回		Sub	Access to the submenu and return from the sub menu
ESC	返回标准模式		ESC	Return to the standard mode
🔒	启用或禁用密码保护, 更改密码		🔒	Enable or disable password protection, change the password
ct	激活或停用 CT 监视		ct	Activate or deactivate CT monitoring
FAC	重建工厂设置		FAC	Re-establish factory settings
InF	查询软件版本	InF	Query software version	
SYS	服务菜单 SYS 限制	SYS	Service menu SYS blocked	
ESC	移动到下一个更高的菜单等级 (向后)	ESC	Move to the next higher menu level (back)	

参数设置

下面的提供的例子告知如何修改报警响应值 R_{an} (< R)。过程如下:

- 按下“MENU / Enter”按钮并且保持 2 秒。闪烁的短符号 < R 出现在显示屏上。
- 按 Enter 确认。闪烁的显示屏用 kΩ 显示当前设置响应值。
- 使用 „向上“ 或 „向下“ 按钮设置适当的值。按按 „Enter“ 确认。闪烁的短符号 < R 出现在显示屏上。
- 你可以这样退出菜单:
 - 按下 „Enter“ 按钮持续 2 秒
 - 或者选择菜单项 ESC 并且按 „Enter“ 确认。

i

显示的区域可以配置为闪烁! 在下图中, 可以执行设备设置的部分并且用椭圆突出显示。

50

菜单模式可以通过按下 „MENU“ 按钮超过 2 秒来访问。

Parameter settings

An example is given below on how to change the alarm response value R_{an} (< R). Proceed as follows:

- Keep the "MENU / Enter" button pressed for 2 seconds. The flashing short symbol < R appears on the display.
- Confirm with Enter. A flashing display shows the currently set response value in kΩ.
- Use the „Up“ or „Down“ button to set the appropriate value. Confirm with „Enter“. The flashing short symbol < R appears on the display.
- You can exit the menu by:
 - pressing the „Enter“ button for 2 s
 - or selecting the menu item ESC and confirming with „Enter“.

i

The areas of the display which can be configured flash! In the figures below, the segments where device settings can be carried out are highlighted by an oval.

50

The menu mode can be accessed by pressing the „MENU“ button for 2 seconds.

设置响应值 R_{an} (< R)

使用此菜单设置要发出报警信号的绝缘值的限制。

Setting the response value R_{an} (< R)

Use this menu to set the limit of the insulation value at which an alarm is to be signalled.

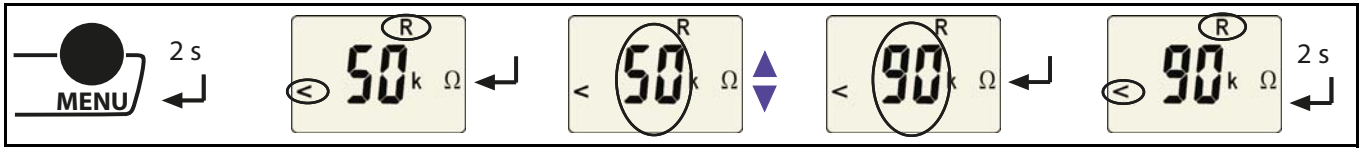

为负载电流监视设置响应值 (A)

Setting of the response value (A) for load current monitoring

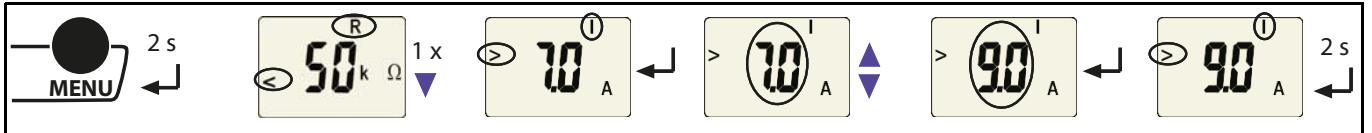

选择报警继电器的工作原理

使用这个菜单去设置报警继电器K1 (1) 到常开工作 (n. o.) 或常闭工作 (n. c.) 的工作原理:

Selecting the operating principle of the alarm relay

Use this menu to set the operating principle of the alarm relay K1 (1) to N/O operation (n.o) or N/C operation (n.c.):

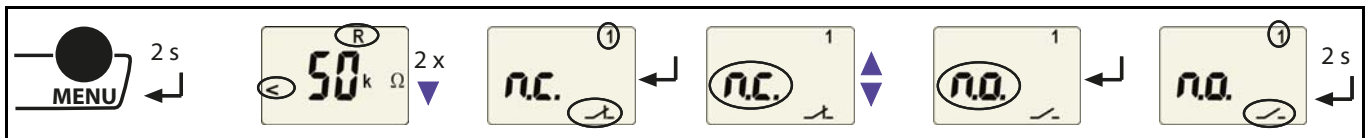

设置 BMS 地址

Setting the BMS address

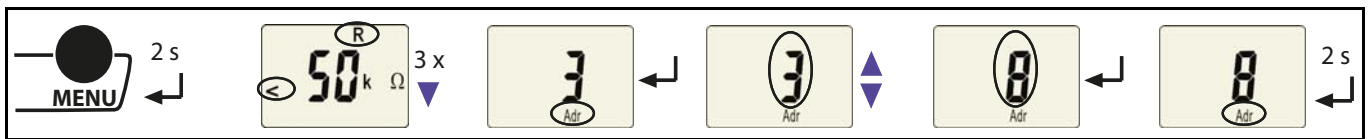

激活自动绝缘故障定位

Activating automatic insulation fault location

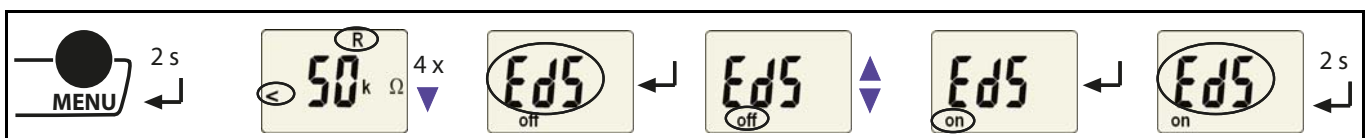

密码保护

这个菜单可以被用于激活密码保护, 修改密码或停用密码保护。只有在激活密码保护之前才能修改密码。

Password protection

This menu can be used to activate password protection, to modify the password or to deactivate password protection. The password can only be changed when the password protection has been activated before.

a) 激活密码保护

a) Activating the password protection

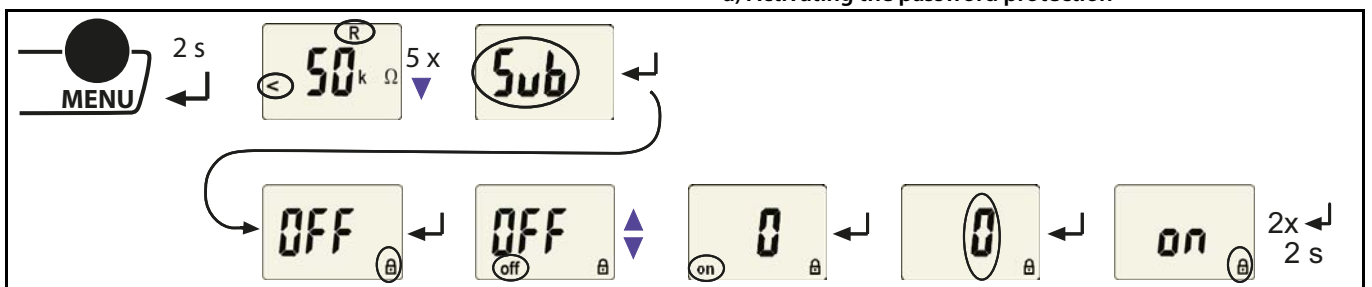

b) 修改密码

b) Changing the password

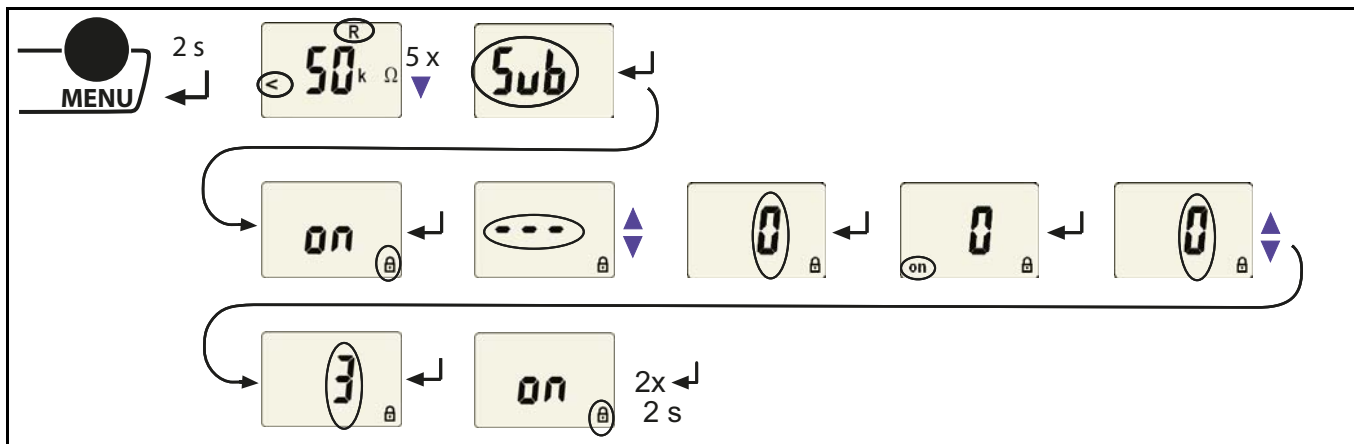

c) 停用密码保护

c) Deactivating the password protection

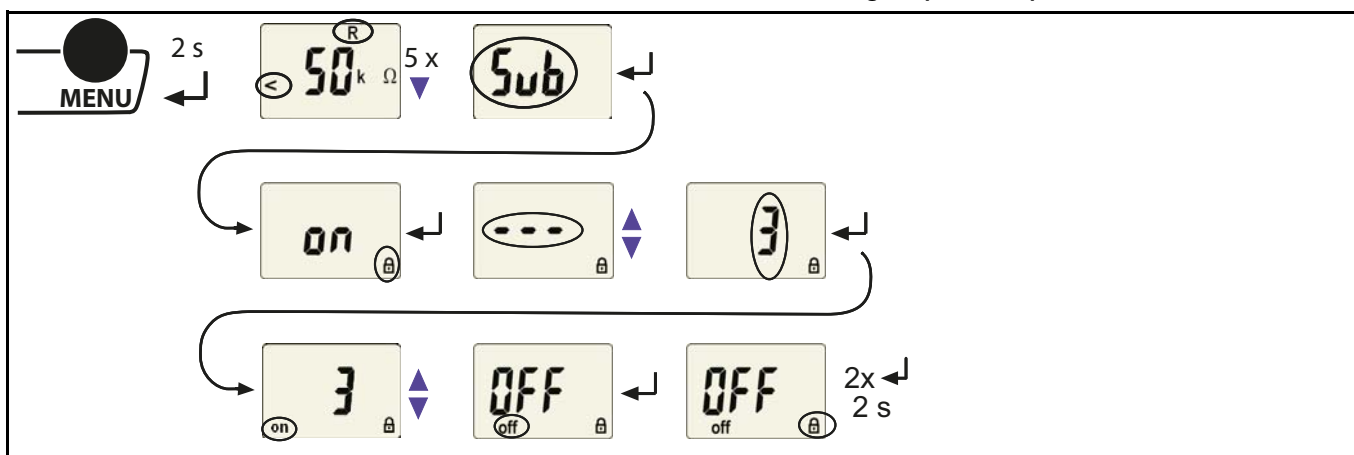

停用 CT 监视功能

Deactivating the CT monitoring function

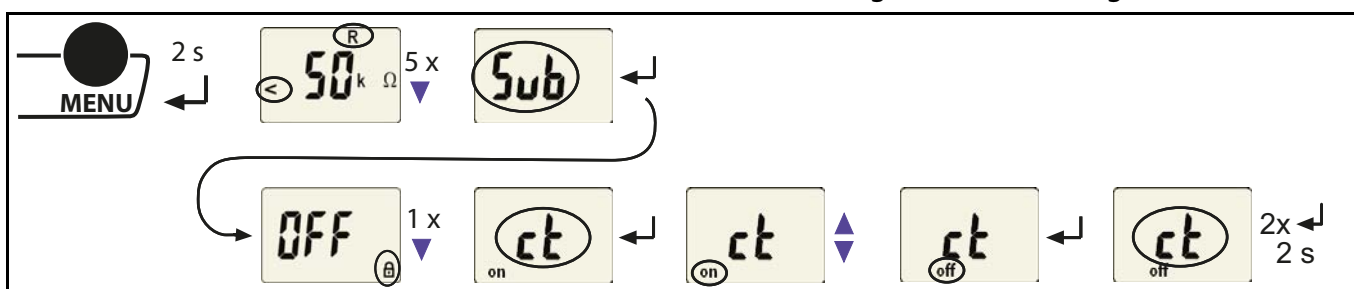

重置设备到它的出厂设置

Resetting the device to its factory settings

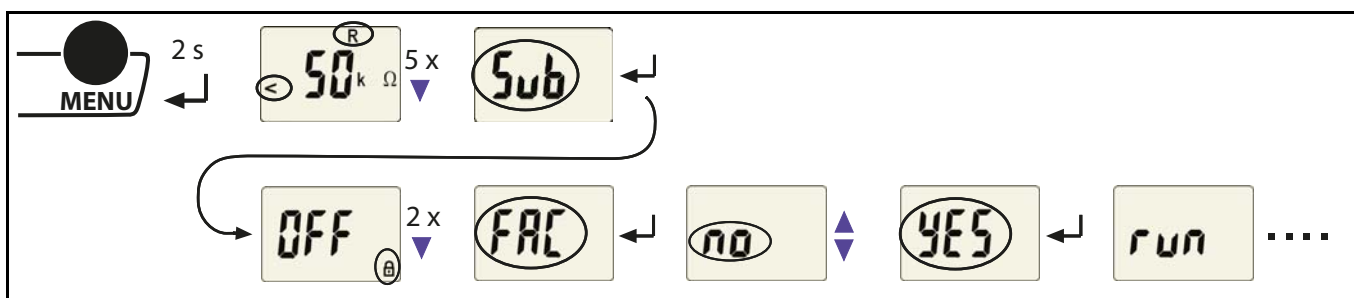

查询设备信息

使用这个菜单查询软件版本 (1.xx)。在激活这个功能后，数据将显示为滚动文本。一次完成通过，你可以使用“向上/向下”按钮选择独立数据部分。

Querying device information

Use this menu to query the software version (1.xx). After activating this function, data will be displayed as a scrolling text. Once one pass is completed you can select individual data sections using the Up/Down buttons.

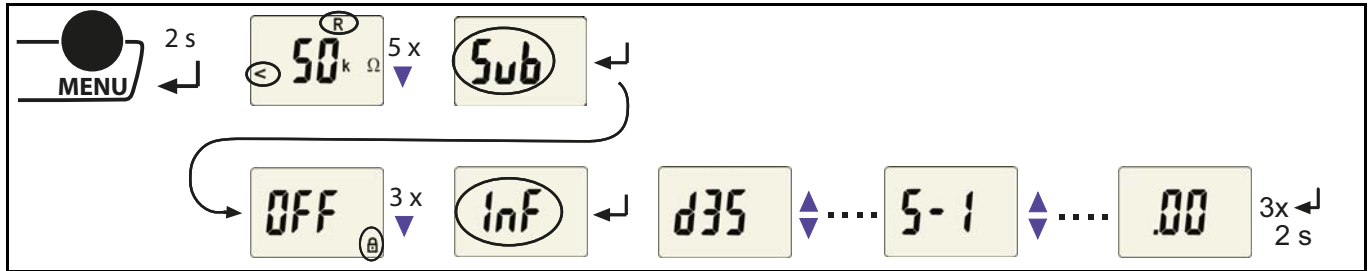

技术参数

绝缘协调符合标准 IEC 60664-1 / IEC 60664-3

额定绝缘电压 250 V
 额定脉冲电压 / 污染等级 4 kV / 3
 保护隔离 (强化绝缘) 介于:
 (L1, L2, E, KE, T1, T2, A, B, Z, Z/k, I) - (11, 12, 14)
 电压测试符合标准 IEC 61010-1 2.21 kV

电源电压

电源电压 U_S = U_n
 功耗 ≤ 6.5 VA

被监视 IT 系统符合 IEC 60364-7-710:2002-11

标称系统电压 U_n AC 70...264 V
 额定频率 f_n 47...63 Hz

绝缘监视符合标准 IEC 61557-8: 2007-01

响应值 R_{an} 50...500 kΩ (50 kΩ)*
 相对的不确定性 ±10 %
 磁滞 25%
 响应时间 t_{an} at $R_F = 0.5 \times R_{an}$ 和 $C_e = 0.5 \mu F$ ≤ 5 s
 用于连接监视的响应时间 PE ≤ 1 h
 允许系统泄漏电容 C_e 5 μF

测量回路

测量电压 U_m ±12 V
 测量电流 I_m (当 $R_F = 0 \Omega$) ≤ 50 μA
 内置直流电阻 R_i ≥ 240 kΩ
 阻抗 Z_i , 当 50 Hz ≥ 200 kΩ
 允许外部直流电压 U_{fg} ≤ DC 300 V

定位电流发射器符合 IEC 61557-9: 2009

定位电流 ≤ 1 mA
 试验周期 / 闲置时间 2 s / 4 s

负载电流监视

响应值, 可调 5...50 A (7 A)*
 相对的不确定性 ± 5 %
 磁滞 4 %
 额定频率 f_n 47...63 Hz
 设定值 负载电流测量:
 变压器 3150 VA 4000 VA 5000 VA 6300 VA 8000 VA 10000 VA
 $I_{alarm 1}$ ~ 14A 18A 22A 28A 35A 45A
 响应时间过载, (50 % to 120 %) < 5 s
 响应时间用于测量电流互感器监视 重启、测试或每小时一次

Technical data

Insulation coordination acc. to IEC 60664-1 / IEC 60664-3

Rated insulation voltage.....250 V
 Rated impulse voltage/pollution degree..... 4 kV / 3
 Protective separation (reinforced insulation) between:
 (L1, L2, E, KE, T1, T2, A, B, Z, Z/k, I) - (11, 12, 14)
 Voltage test according to IEC 61010-1 2.21 kV

Supply voltage

Supply voltage U_S = U_n
 Power consumption ≤ 6.5 VA

IT system being monitored acc. IEC 60364-7-710:2002-11

Nominal system voltage U_n AC 70...264 V
 Rated frequency f_n 47...63 Hz

Insulation monitoring acc. to IEC 61557-8: 2007-01

Response value R_{an}50...500 kΩ (50 kΩ)*
 Relative uncertainty..... ±10 %
 Hysteresis..... 25%
 Response time t_{an} at $R_F = 0.5 \times R_{an}$ and $C_e = 0.5 \mu F$ ≤ 5 s
 Response time for connection monitoring PE ≤ 1 h
 Permissible system leakage capacitance C_e 5 μF

Measuring circuit

Measuring voltage U_m ±12 V
 Measuring current I_m (at $R_F = 0 \Omega$) ≤ 50 μA
 Internal DC resistance R_i ≥ 240 kΩ
 Impedance Z_i , at 50 Hz ≥ 200 kΩ
 Permissible extraneous DC voltage U_{fg} ≤ DC 300 V

Locating current injector acc. to IEC 61557-9: 2009

Locating current ≤ 1 mA
 Test cycle/idle time 2 s / 4 s

Load current monitoring

Response value, adjustable..... 5...50 A (7 A)*
 Relative uncertainty..... ± 5 %
 Hysteresis..... 4 %
 Rated frequency f_n 47...63 Hz
 Setting value load current measurement:
 Transformer 3150 VA 4000 VA 5000 VA 6300 VA 8000 VA 10000 VA
 $I_{alarm 1}$ ~ 14A 18A 22A 28A 35A 45A
 Response time overload, (50 % to 120 %) < 5 s
 Response time for measuring current transformer monitoring at restart, test or every 1 h

温度监视

响应值 (固定值)	4 kΩ
响应值 (固定值)	1.6 kΩ
PTC 电阻符合标准 DIN 44081	最大串联 6 个
相对的不确定性	± 10 %
响应值超温	< 2 s
响应时间连接故障 PTC 电阻	< 2 s

显示, 记忆

液晶显示	多功能, 无照明
绝缘电阻测量值	10 kΩ...1 MΩ
操作不确定性	± 10 %, ± 2 kΩ
负载电流测量值 (以设置响应值的 % 表示)	10 %...199 %
操作不确定性	± 5 %, ± 0.2 A
密码	on, off / 0...999 (off, 0)*

接口

接口 / 协议	RS-485 / BMS
波特率	9.6 kbit / s
电缆长度	0...1200 m
推荐电缆 (屏蔽, 屏蔽端连接到 PE 线的一个底端)	至少 J-Y (St)Y 2 x 0.6
终端电阻	120 Ω (0.25 W), 内置, 可开关的
设备地址, BMS 总线	2...90 (3)*

测量电流互感器 STW2 和温度传感器的接口

电缆长度:	
单芯线 > 0.5 mm ²	≤ 1 m
单芯线, 双绞线 > 0.5 mm ²	≤ 10 m
双绞线, 屏蔽线 > 0.5 mm ²	≤ 40 m
推荐电缆, 最小	J-Y (St)Y 2x0.6; 屏蔽一端连接到 PE 线

开关元件

数量	1 组转换触点
操作原理	常闭操作 / 常开操作 (常闭操作)*
电气耐久性	10.000 次
触点参数符合标准 IEC 60947-5-1	
使用类别	AC -13 AC -14 DC-12 DC-12 DC-12
额定工作电压	230 V 230 V 24 V 110 V 220 V
额定工作电流	5 A... 3 A... 1 A... 0.2 A... 0.1 A
最小接触负载	在 AC / DC 10 V 时, 1 mA

环境 / EMC

EMC	IEC 61326-2-4
工作温度	-25 °C...+55 °C
气候条件分类符合标准 IEC 60721:	
固定使用 (IEC 60721-3-3)	3K5 (除冰和冰水化合物)
运输 (IEC 60721-3-2)	2K3 (除冰和冰水化合物)
长期存储 (IEC 60721-3-1)	1K4 (除冰和冰水化合物)
机械条件分类符合标准 IEC 60721:	
固定使用 (IEC 60721-3-3)	3M4
运输 (IEC 60721-3-2)	2M2
长期存储 (IEC 60721-3-1)	1M3

连接

连接类型	推线端子
连接属性:	
刚性线	0.2...2.5 mm ² (AWG 24...14)
柔性线不带金属套圈	0.75...2.5 mm ² (AWG 19...14)
柔性线带金属套圈	0.2...1.5 mm ² (AWG 24...16)
剥线长度	10 mm
开启力度	50 N
测试打开, 直径	2.1 mm

Temperature monitoring

Response value (fixed value)	4 kΩ
Release value (fixed value)	1.6 kΩ
PTC resistors acc. to DIN 44081	max. 6 in series
Relative uncertainty	± 10 %
Response time overtemperature	< 2 s
Response time connection fault PTC resistors	< 2 s

Displays, memory

LC display	multifunctional, not illuminated
Measured value insulation resistance	10 kΩ...1 MΩ
Operating uncertainty	± 10 %, ± 2 kΩ
Measured value load current (as % of the set response value)	10 %...199 %
Operating uncertainty	± 5 %, ± 0.2 A
Password	on, off / 0...999 (off, 0)*

Interface

Interface/protocol	RS-485 / BMS
Baud rate	9.6 kbit / s
Cable length	0...1200 m
Recommended cable (shielded, shield connected to PE at one end)	at least J-Y (St)Y 2 x 0.6
Terminating resistor	120 Ω (0.25 W), internal, switchable
Device address, BMS bus	2...90 (3)*

Interfaces for measuring current transformer STW2 and temperature sensor

电缆长度:	
Single wire > 0.5 mm ²	≤ 1 m
Single wire, twisted > 0.5 mm ²	≤ 10 m
Twisted pair, shielded > 0.5 mm ²	≤ 40 m
Recommended cable	min. J-Y (St)Y 2x0.6; Shield on one side connected to PE

Switching elements

Number	1 changeover contact
Operating principle	N/C operation / N/O operation (N/C operation)*
Electrical endurance	10.000 cycles
Contact data acc. to IEC 60947-5-1	
Utilisation category	AC -13... AC -14... DC-12... DC-12... DC-12
Rated operational voltage	230V...230V...24V...110V...220V
Rated operational current	5 A...3 A...1 A...0.2 A...0.1 A
Minimum contact load	1 mA at AC / DC 10 V

Environment / EMC

EMC	IEC 61326-2-4
Operating temperature	-25 °C...+55 °C
Classification of climatic conditions acc. to IEC 60721:	
Stationary use (IEC 60721-3-3)	3K5 (except condensation and formation of ice)
Transport (IEC 60721-3-2)	2K3 (except condensation and formation of ice)
Long-term storage (IEC 60721-3-1)	1K4 (except condensation and formation of ice)
Classification of mechanical conditions acc. to IEC 60721:	
Stationary use (IEC 60721-3-3)	3M4
Transportation (IEC 60721-3-2)	2M2
Long-time storage (IEC 60721-3-1)	1M3

Connection

Connection type	push-wire terminals
Connection properties:	
Rigid	0.2...2.5 mm ² (AWG 24...14)
Flexible without ferrules	0.75...2.5 mm ² (AWG 19...14)
Flexible with ferrules	0.2...1.5 mm ² (AWG 24...16)
Stripped length	10 mm
Opening force	50 N
Test opening, diameter	2.1 mm

其他

工作模式 连续工作
 正常使用位置 任何
 防护等级, 内部组件 (DIN EN 60529) IP30
 防护等级, 端子 (DIN EN 60529) IP20
 外壳材料 塑料
 燃烧等级 UL94V-0
 螺丝安装 2 x M4
 DIN 导轨安装符合标准 IEC 60715
 软件版本 D355 V1.0x
 重量 150 g
 () * = 出厂设置

订货信息

型号 电源电压 $U_s = U_n^*$ 订货号
 isoMED427P-CXAC 70...264 V, 47...63 Hz B72075302
 * 电压范围的绝对值

STW2 测量电流互感器 B942709
 ES0107 温度传感元件, PTC B924186
 XM420 安装件 B990994

Other

Operating mode continuous operation
 Position of normal use any
 Degree of protection, internal components (DIN EN 60529) IP30
 Degree of protection, terminals (DIN EN 60529) IP20
 Enclosure material polycarbonate
 Flammability class UL94V-0
 Screw mounting 2 x M4
 DIN rail mounting acc. to IEC 60715
 Software version D355 V1.0x
 Weight 150 g
 () * = factory setting

Ordering information

Type Supply voltage $U_s = U_n^*$ Art. No.
 isoMED427P-CX AC 70...264 V, 47...63 Hz B72075302
 *Absolute values of the voltage range

STW2 Measuring current transformer B942709
 ES0107 Temperature sensing element, PTC B924186
 XM420 Mounting frame B990994

推荐的设备组合

Recommended device combinations

Device combination	Insulation monitoring device	Insulation fault locator	Alarm indicator and test combination
1	isoMED427P-CX = S	EDS461-L = S EDS461-D = S	MK2430 or MK800 = M
2	isoMED427P-CX = S	EDS151 = S	MK2430 or MK800 = M
3	isoMED427P-CX = S	EDS461-L = S EDS461-D = S	MK2430 or MK800 = M + MK2007 = S
4	isoMED427P-CX = S	EDS151 = S	MK2430 or MK800 = M + MK2007 = S
S = Slave, M = Master			

每个 BMS 通道的报警和工作信息

isoMED427P-CX 能为其他总线设备提供报警和工作信息。这些信息可以由总线主机查询。

报警 信息

BMS channel	Meaning
1	Insulation fault: Insulation resistance R_F below the response value R_{an}
2	Overcurrent in %: Load current above the response value
3	Overtemperature: Transformer temperature above the response value
4	Connection fault PE
5	CT connection for current measurement interrupted
6	CT connection for current measurement short-circuited
7	Device fault, internal
9	Start of the EDS system in continuous operation without idle time

Alarm and operating messages of each BMS channel

isoMED427P makes alarm and operating messages available for other bus devices.

These messages can be queried by a bus Master.

Alarm messages

操作消息

Operating messages

BMS 通道 BMS channel	含义 Meaning
1	Currently measured insulation resistance R_F
2	Currently measured load current in %

保留版权。
复制和转载
必须由出版商认可。
修改受管制！

© Bender GmbH & Co. KG



BENDER Group

All rights reserved.
Reprinting and duplicating
only with permission of the publisher.

Subject to change!

© Bender GmbH & Co. KG



BENDER Group

Bender GmbH & Co. KG
Londorfer Str. 65 • 35305 Gruenberg • Germany

Tel.: +49 6401 807-0
Fax: +49 6401 807-259

E-Mail: info@bender.de
www.bender.de